

TEAC®



SERVICE MANUAL

C-3RX

Stereo Cassette Deck

2 PARTS LOCATION

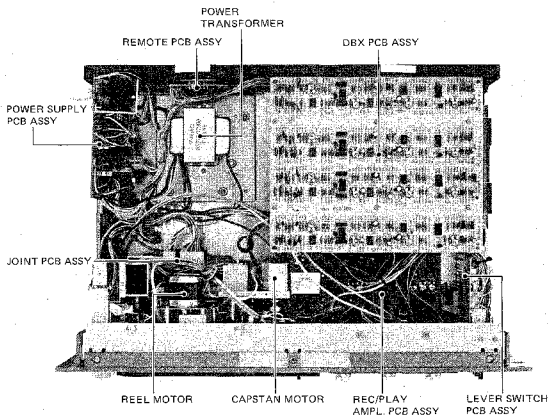

Fig. 2-1

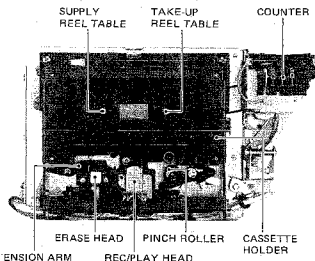

Fig. 2-2

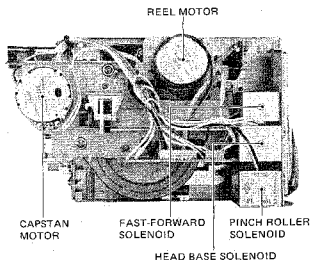

Fig. 2-3

4 MECHANICAL ADJUSTMENTS AND CHECKS

4-1 REEL TORQUE

1. Load the cassette torque meter on the deck and read the pointer indication on the dial scale for each tape transport operation.

The measured torque should be within the following values:

Take-up: 45 to 65 g-cm (0.62 to 0.90 oz-inch)

Supply: 3 to 8 g-cm (0.042 to 0.11 oz-inch)

F.F. and REW: 90 to 160 g-cm (1.25 to 2.22 oz-inch)

4-2 PINCH ROLLER PRESSURE

1. With the cassette holder shut and no tape loaded, put the deck in PLAY mode.
2. Hook a spring scale on the top of the pinch roller assembly plate, as shown in the illustration.
3. Pull the scale down until there is sufficient force to separate the pinch roller from the capstan shaft.
4. Ease pressure until the pinch roller makes just enough contact with the capstan shaft so that the pinch roller just begins to turn. At this point, note the reading on the scale. It should be from 390 g to 490 g (13.8 oz. to 17.3 oz.)
5. If the pressure is not within the prescribed specifications, it may be adjusted by first removing the pinch roller spring from the pinch roller assembly and then bending the spring as shown in the illustration.

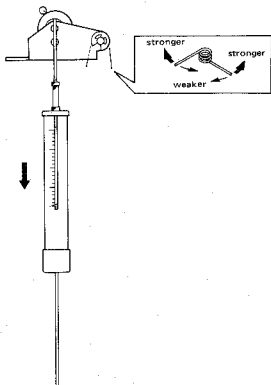

Fig. 4-1

4-3 HEAD BASE PLATE POSITIONING

1. Set the deck in the PLAY mode.
2. Push the head base plate by hand in the direction of the arrow and check that the head base plate and the stopper portion of the mechanism chassis make contact.
3. If there is any clearance, loosen the two screws on the head base plate solenoid and reposition the solenoid until the clearance is eliminated.

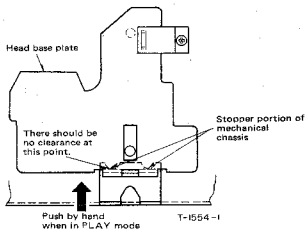

Fig. 4-2

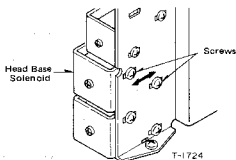

Fig. 4-3 Head base solenoid location

4-4 CAPSTAN ASSEMBLY THRUST

1. Turn the thrust adjusting screw so that thrust of the capstan shaft is within 0.05 mm to 0.15 mm.

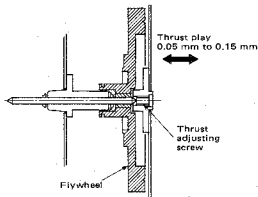

Fig. 4-4

4-5 TAPE SPEED

1. Connect a frequency counter to the deck as shown in Fig. 4-5.
2. Play a tape for about five minutes to warm up the deck, then load a TEAC MTT-111 test tape containing a 3000-Hz test tone and play the test tape from the beginning.
3. While the tape is playing, use a common slotted screwdriver with the handle completely insulated from the blade, and adjust the control on the capstan motor (as far as possible) for a reading of 3000 Hz (± 5 Hz) on the frequency counter.
4. Play the tape at the beginning and at the end, and check that the speed deviation is within the prescribed limits by observing that the reading on the frequency counter never deviates more than ± 45 Hz from 3000 Hz, nor drifts more than 30 Hz at any given time.
5. If the tape speed is not within the prescribed specifications, check the pinch roller pressure and the tape transport mechanism for any abnormality, and make sure the tape path is clean.

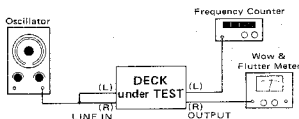

Fig. 4-5

Tape speed control

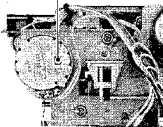

Fig. 4-6 Tape speed adjustment location

4-6 WOW AND FLUTTER

Note: These measurements should be made at the beginning, middle, and the end of the tape.

1) PLAYBACK

1. Connect a wow-and-flutter meter to the deck as shown in Fig. 4-5.
2. Load and play a TEAC MTT-111 test tape.
3. Check that the reading on the wow-and-flutter meter is within 0.08% (WRMS).

2) SIMULTANEOUS RECORD/PLAYBACK METHOD STANDARD Speed

4. Load a TEAC MTT-501 test tape (blank) and record a 3000-Hz signal.
 5. With the MONITOR switch in the TAPE position, note the reading on the wow-and-flutter meter, it should not be more than 0.25% (RMS).
- ### 3) NON-SIMULTANEOUS RECORD/PLAYBACK METHOD
6. Rewind the tape to the beginning of the recorded section previously made in step 4, and play it.
 7. The wow and flutter should not be more than 0.25% (RMS).

4-7 MICROSWITCH (A) ASSEMBLY CLEARANCE

1. Insert a blank cassette and close the cassette holder.
2. Loosen the two screws on the microswitch (A).
3. Move the switch so that actuator of the switch contacts the safety lever.
4. Adjust the switch position to obtain a clearance of between 0.1 mm to 0.3 mm.
5. Retighten the screws.

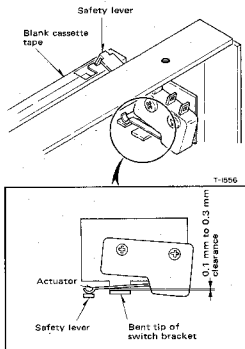

Fig. 4-7

4-8 MICROSWITCH (B) ASSEMBLY CLEARANCE

1. Push the EJECT button to open the cassette holder.
2. Loosen the two screws on the microswitch (B).
3. Move the switch so that switch actuator contacts the bent projecting portion of the eject lever.
4. Adjust the switch position to obtain a clearance of approximately 1 mm.
5. Retighten the screws.

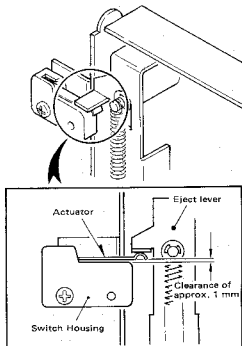

Fig. 4-8

4-9 LUBRICATION

Lubrication is only required when parts are replaced. For this purpose, use the oil and grease specified below.

Oil: TEAC spindle oil (from TEAC TZ-255 oil kit), Mobil D.T.E. Oil Light, or equivalent

Grease: ORE-LUBE G1/3 or equivalent

1. Apply a drop of oil with an oil applicator to a point about 1/3 the way down the shaft (from the free end) of the flywheel, then insert the shaft into the capstan housing.
2. Apply a suitable amount of light grease to the well of the flywheel bearing.

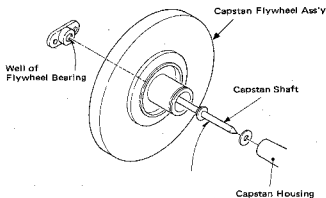

Fig. 4-9

4-10 VOLTAGE SELECTION (FOR GENERAL EXPORT MODELS)

1. Always disconnect the power line cord before making these adjustments.
2. Remove the top cover of the deck by removing the screws from the sides.
3. Locate the voltage selector, shown in the illustration, to the front of the power transformer.
4. Loosen the two screws in the jumper bar and move the bar so that it jumps the opposing terminals marked with the required voltage (100, 120, 220 or 240).
5. Retighten the screws and replace the top cover.

4-11 AC POWER LINE FREQUENCY

Since the C-3RX uses a DC servo motor, 50 Hz or 60 Hz operation is permitted without any change in power line frequency.

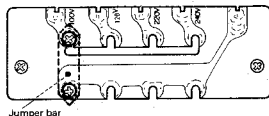

Fig. 4-10

5 ELECTRICAL ADJUSTMENTS AND CHECKS

PRECAUTIONS

1. Before beginning any checks or adjustments, clean and demagnetize the entire tape path.
2. Make sure the deck is properly set for the voltage in your locality.
3. In general, adjustments and checks are done in the order of L-ch then R-ch. Double REF. NOs, and test point designations indicate L-ch/R-ch.
(Example: R11/R21)
4. For this deck, 0 dB is referenced to 0.775 V. If you are using an AC voltmeter which references 0 dB to 1 V, appropriate compensation should be made.
5. The AC voltmeter used in the procedures must have an input impedance of 1M ohms or more.
6. Note the "Deck settings" at the top of each chart. These settings must be used for all the checks in each chart unless explicitly stated otherwise.

-70 dB or more ... What does it mean?

In reference to some specifications, you may come across an expression like: "-70 dB or more". This means that the lower the value of this specification, the greater the absolute value of the specification and the better the performance of the deck. For instance, a noise floor of -76 dB is better than -70 dB, because this means that the level of noise is lower. So in this case, "-70 dB or more" means at least as good a value as -70 dB and maybe even better, i.e., -71 dB.

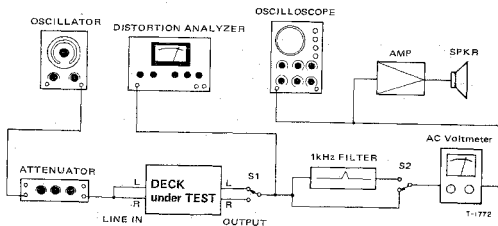

Fig. 5-1 Basic test setup

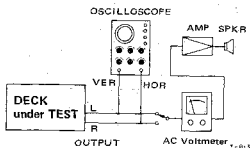

Fig. 5-2 Test setup for azimuth check

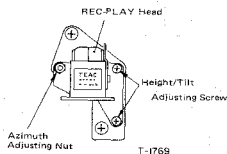

Fig. 5-3 Azimuth adj. nut location

Deck settings:
 MONITOR sw.: TAPE
 NR SYSTEM sw.: OUT
 EQ sw.: METAL

TEAC test tapes:
 MTT-150: For Dolby level calibration
 MTT-316: For playback frequency response check for METAL, Co(CrO₂)
 MTT-216: For playback response check for NORMAL

2 PLAYBACK PERFORMANCE

ITEM	SETTING	INPUT SIGNAL	ADJUST (or CHECK)	MEASURING POINT:	REMARKS
				RESULT	
1. REC/PLAY head azimuth	Conn.: Fig. 5-2 OUTPUT cont.: convenient output level position	MTT-316 (12.5 kHz)	Azimuth nut of R-P heads (Fig. 5-3)	OUTPUT: • Phase: about 0° on 'scope (Fig. 5-4) • Max. output on VTVM	
2. Phase shift	Same as above	MTT-316	Check	OUTPUT: Phase: 45° min. (315 Hz) 90° min. (12.5 kHz)	
3. Specified output level	—	MTT-150	R11/R21	TP1/TP2: -2.5 dB (581 mV)	• Spec. setting of OUTPUT cont. • Spec. output level
	—	MTT-150	OUTPUT cont.	OUTPUT: -5 dB (436 mV)	
IMPORTANT: Do not change the OUTPUT cont. setting after establishing the proper settings as above.					
1. PEAK LEVEL meter	—	MTT-150	R12/R22	PEAK LEVEL meter: 0 dB	
3. Frequency response	EQ: METAL, Co(CrO ₂) Adjust for 10 kHz signal at same level as ref. signal (315 Hz)	MTT-316	R10/R20	OUTPUT: Fig. 5-5	
	EQ: NORMAL	MTT-316	Check	OUTPUT: At 10 kHz, should be 3 dB to 6 dB higher than measured in above step.	
3. Signal-to-noise ratio	EQ: METAL Co(CrO ₂) NORMAL	Fully-erased tape: (Use bulk tape eraser) .METAL .MTT-5061 .MTT-501	Check	OUTPUT: -52 dB min. ...48dB min.	Ratio of spec. output of -5 dB to noise

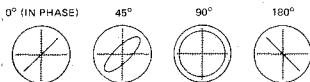

Fig. 5-4 Confirming phase relationship

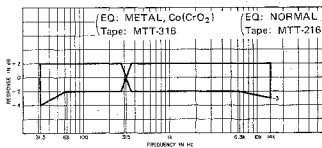

Fig. 5-5 Playback frequency response

5-2 MONITOR PERFORMANCE

Deck settings:
REC-PAUSE mode
MONITOR sw.: SOURCE

NR SYSTEM sw.:
INPUT sw.:
OUTPUT cont.:

OUT
LINE
Specified position (item 3)

ITEM	SETTING		INPUT SIGNAL	ADJUST (or CHECK)	MEASURING POINT:	REMARKS
					RESULT	
7. Min. input level	RECORD cont.: Max.	INPUT sw.: MIC	MIC: 400 Hz/-67 dB (346 μ V)	Check	OUTPUT: -5 dB \pm 3 dB (308 mV to 615 mV)	MIC min. input level
		INPUT sw.: LINE	LINE IN: 400 Hz/-19 dB (86.9 mV)	Check	OUTPUT: -5 dB \pm 3 dB (308 mV to 615 mV)	LINE min. input level
8. LINE specified input level	-		LINE IN: 400 Hz/-9 dB (275 mV)	RECORD cont. (L/R)	OUTPUT: -5 dB (436 mV)	Specified setting of RE- CORD cont.
	-		LINE IN: 400 Hz/-9 dB (275 mV)	Check	DOLBY 7P (TP1/TP2): -2.5 dB \pm 0.5 dB (548 mV to 615 mV)	
IMPORTANT: Do not change the setting of the RECORD or OUTPUT controls, after establishing their setting as above.						
9. PEAK LEVEL meter	-		LINE IN: 400 Hz/-9 dB (275 mV)	Check	PEAK LEVEL meter: 0 dB \pm 1 dB	
10. "TEST IN"	INPUT sw.: TEST		LINE IN: 400 Hz/-29 dB (27.5 mV)	Check	PEAK LEVEL meter: 0 dB \pm 2 dB	
11. PHONES output level	Connection: Fig. 5-6		LINE IN: 400 Hz/-9 dB (275 mV)	Check	PHONES: -15.8 dB \pm 3 dB (89.0 mV to 178 mV)	

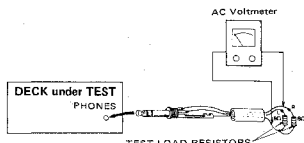

Fig. 5-6 Test setup for PHONES check

Deck settings:

MONITOR sw.: TAPE
NR SYSTEM sw.: OUT
INPUT sw.: LINE
ADJUST/PRE-SET sw.: PRE-SET
OUTPUT cont.: Specified position (item 3)
RECORD cont. (L/R): Specified position (item 8)

TEAC test tapes:

MTT-5061: For record test with Co(CrO₂)
MTT-501: For record test with NORMAL
MTT-5072: For record test with METAL

5-3 RECORDING PERFORMANCE

ITEM	SETTING	INPUT SIGNAL	ADJUST (or CHECK)	MEASURING POINT:	REMARKS
				RESULT	
12. BIAS trap	Record-pause mode	LINE IN: No signal	L104/L204	BIAS TRAP TP (TP3/TP4): Min. reading	
13. Record-bias	BIAS, EQ: METAL Tape: MTT-5072	LINE IN: 400 Hz & 10 kHz alternately/-42 dB (6.15 mV)	R15/R25	OUTPUT: Nearly equal level at both frequencies	
	BIAS, EQ: Co(CrO ₂) Tape: MTT-5061	LINE IN: 400 Hz & 10 kHz alternately/-42 dB (6.15 mV)	R14/R24	OUTPUT: Nearly equal level at both frequencies	
	BIAS, EQ: NORMAL Tape: MTT-501	LINE IN: 400 Hz & 10 kHz alternately/-42 dB (6.15 mV)	R13/R23	OUTPUT: Nearly equal level at both frequencies	

ITEM	SETTING	INPUT SIGNAL	ADJUST (or CHECK)	MEASURING POINT:	REMARKS
				RESULT	
14. Record level	BIAS, EQ: MTT-5072 Tape: METAL	LINE IN: 400 Hz/-12 dB (195 mV)	R16/R26	OUTPUT: -8 dB (308 mV)	
	BIAS, EQ: Co(CrO ₂) Tape: MTT-5061	LINE IN: 400 Hz/-12 dB (195 mV)	R17/R27	OUTPUT: -8 dB (308 mV)	
	BIAS, EQ: NORMAL Tape: MTT-501	LINE IN: 400 Hz/-12 dB (195 mV)	R18/R28	OUTPUT: -8 dB (308 mV)	
15. Frequency response	BIAS, EQ: METAL Tape: MTT-5072	LINE IN: Required signal/ -42 dB (6.15 mV)	Check	OUTPUT: Fig. 5-7	
	BIAS, EQ: Co(CrO ₂) Tape: MTT-5061	LINE IN: Required signal/ -42 dB (6.15 mV)	Check	OUTPUT: Fig. 5-7	
	BIAS, EQ: NORMAL Tape: MTT-501	LINE IN: Required signal/ -42 dB (6.15 mV)	Check	OUTPUT: Fig. 5-8	
	If frequency response is out of specification, recheck #13, "Record bias".				
16. Total harmonic distortion	Same as above	LINE IN: 400 Hz/-12 dB (195 mV)	Check	OUTPUT: 2% or less distortion	
7. Signal-to-noise ratio	BIAS, EQ: METAL Tape: MTT-5072	LINE IN: 1 kHz/-9 dB (275 mV) ↓ no signal	Check	OUTPUT: 48 dB min.	Ratio of specified output of -5 dB to noise
	BIAS, EQ: Co(CrO ₂) Tape: MTT-5061	LINE IN: 1 kHz/-9 dB (275 mV) ↓ no signal	Check	OUTPUT: 48 dB min.	
	BIAS, EQ: NORMAL Tape: MTT-501	LINE IN: 1 kHz/-9 dB (275 mV) ↓ no signal	Check	OUTPUT: 48 dB min.	
8. Erase efficiency	<ul style="list-style-type: none"> • Connection is same as in Fig. 5-1, but engage 1-kHz filter. • Record a 1-kHz signal. Rewind tape to midpoint of recorded portion. Record a "no signal" portion. Find the difference between the 1-kHz portion and the "no-signal" portion. 				
	BIAS, EQ: METAL Tape: MTT-5072	LINE IN: 1 kHz/±1 dB (0.889 V) ↓ no signal	Check	OUTPUT: 65 dB min. ratio	Ref. output level: +5 dB (1.38V)

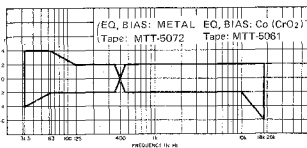

Fig. 5-7 Overall frequency response
[METAL, Co(CrO₂)]

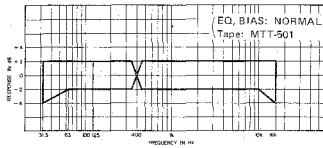

Fig. 5-8 Overall frequency response
[NORMAL]

ITEM	SETTING	INPUT SIGNAL	ADJUST (or CHECK)	MEASURING POINT:	REMARKS	
				RESULT		
19. REC MUTE function	<ul style="list-style-type: none"> • Connection: Fig. 5-1, but engage 1-kHz filter. • Record a 1-kHz signal. Push REC MUTE button for several seconds. Rewind and play the tape. Find the difference between the 1-kHz portion and the "no-signal" portion. 					
	BIAS, EQ: Co(CrO ₂) Tape: MTT-5061	LINE IN: 1 kHz/+1 dB (0.869 V) ↓ no signal	Check	OUTPUT: 65 dB min. ratio	Ref. output level: +5 dB (1.38 V)	
20. Channel separation	<ul style="list-style-type: none"> • Connection: Fig. 5-1, but do not connect LINE IN (R), and engage 1-kHz filter. • Set the deck to record mode. Find the difference between the 1-kHz recorded portion (L-ch) and the "no signal" portion (R-ch). 					
	BIAS, EQ: Co(CrO ₂) Tape: MTT-5061	LINE IN: L-ch: 1 kHz/-9 dB (275 mV) R-ch: No signal	Check	OUTPUT: 35 dB min. ratio		
21. Adjacent track crosstalk	<ul style="list-style-type: none"> • Connection: Fig. 5-1, but do not connect LINE IN (L) and OUTPUT (L). • Record a 125-Hz signal on R-ch and note output level. Invert tape and play R-ch track. Check leakage level against the output reference of previously recorded portion. 					
	BIAS, EQ: Co(CrO ₂) Tape: MTT-5061	LINE IN: L-ch: No signal R-ch: 125 Hz/-9 dB (275 mV)	Check	OUTPUT: 40 dB min. ratio		
22. DOLBY NR effect	<ul style="list-style-type: none"> • Record a 1-kHz signal with NR SYSTEM switch OUT. Play this portion with NR SYSTEM switch set to OUT and set to NR. Obtain the difference in output level between OUT and NR positions. Repeat the above process using a 10-kHz signal. 					
	BIAS, EQ: Co(CrO ₂) Tape: MTT-5061	LINE IN: 1 kHz/-29 dB (27.5 mV)	Check	OUTPUT: Variation of 3 dB to 8 dB		
	BIAS, EQ: Co(CrO ₂) Tape: MTT-5061	LINE IN: 10 kHz/-39 dB (8.69 mV)	Check	OUTPUT: Variation of 8 dB to 12 dB		
23. BIAS/REC CALIBRATION (on front panel)	BIAS, EQ: Co(CrO ₂) Tape: MTT-5061					
	INPUT: TEST ADJUST/PRE-SET sw.: ADJUST					
	R35/R45 fully CCW (⊖) R30/R40 fully CW (⊕) Record-pause mode MONITOR sw.: SOURCE	LINE IN: 1 kHz/-29 dB (27.5 mV)	RECORD cont's (L/R)	OUTPUT: -25 dB (43.6 mV)		
	Record-pause mode MONITOR sw.: SOURCE	LINE IN: 1 kHz/-29 dB (27.5 mV)	Check	PEAK LEVEL meter: 0 dB ±2 dB		
	Record-play mode MONITOR sw.: TAPE	LINE IN: 1 kHz/-29 dB (27.5 mV)		While rotating R35/R45 trim-pots clockwise, check that the difference in OUTPUT level between the setting where a maximum output value is obtained and when the trim-pot is set fully clockwise is more than 4 dB.	R35/R45 variable range checks	
	Record-play mode MONITOR sw.: TAPE	LINE IN: 1 kHz/-29 dB (27.5 mV)		Set R35/R45 in the position corresponding to maximum output value. Check that, when R30/R40 is rotated from fully CW position to fully CCW position, OUTPUT level is reduced by more than 10 dB.	R30/R40 variable range checks	
Record-play mode MONITOR sw.: TAPE SOURCE ↓	LINE IN: 400 Hz/-29 dB (27.5 mV)	R30/R40	OUTPUT: Equal level with MONITOR switch, TAPE and SOURCE			
Record-play mode MONITOR sw.: TAPE	LINE IN: 400 Hz/-29 dB 6.3 kHz/-29 dB 12.5 kHz/-29 dB	R35/R45	OUTPUT: Flat level between all 3 signals			

Deck settings:

MONITOR sw.: TAPE
 NR SYSTEM sw.: dbx
 INPUT sw.: LINE
 ADJUST/PRE-SET sw.: PRE-SET
 OUTPUT cont.: Specified position (item 3)

TEAC test tapes:

MTT-5061: For record test with Co(CrO₂)
 MTT-501: For record test with NORMAL
 MTT-5072: For record test with METAL

NOTE:
 Test this performance only after you are sure that the "5-6 DBX PERFORMANCE" is correct.

5-4 DBX PERFORMANCE

ITEM	SETTING	INPUT SIGNAL	ADJUST (or CHECK)	MEASURING POINT:	REMARKS
				RESULT	
24. Encoder level setting	-	LINE IN: 1 kHz/-9 dB (275 mV)	RECORD cont. (L/R)	A/C term. on dbx PCB: -2.5 dB (590 mV)	IMPORTANT: Do not change the setting of the RECORD or OUTPUT controls after establishing this step.
		LINE IN: 1 kHz/-14.5 dB (146 mV)	R76/R86	TP1/TP3 on dbx PCB: -8 dB (308 mV) (Ref.1)	
25. Encoder operation check (level)	-	LINE IN: 1 kHz/-74.5 dB (146 μV)	Check	TP1/TP3 on dbx PCB: -30 dB ±0.5 dB variation from Ref. 1	
		LINE IN: 1 kHz/+5.5 dB (1.46V)	Check	TP1/TP3 on dbx PCB: +10 dB ±0.5 dB variation from Ref. 1	
26. Encoder operation check (frequency)	-	LINE IN: 100 Hz/-14.5 dB (146 mV)	Check	TP1/TP3 on dbx PCB: ±0.5 dB ±1 dB deviation from Ref. 1	
		LINE IN: 10 kHz/-14.5 dB	Check	TP1/TP3 on dbx PCB: -2.5 dB ±1 dB deviation from Ref. 1	
27. Encoder operation check (S/N ratio)	-	LINE IN: No signal	Check	TP1/TP3 on dbx PCB: Noise level: -40 dB or less	
28. Decoder level setting	RECORD-PLAY mode BIAS, EQ: Co(CrO ₂) Tape: MTT-5061	NR SYSTEM: dbx LINE IN: 1 kHz/-14.5 dB (146 mV)	R73/R83	OUTPUT: -10.5 dB (231 mV) (Ref.2)	
		NR SYSTEM: OUT LINE IN: 1 kHz/-14.5 dB	Check	OUTPUT: ±0.5 dB from Ref. 2	
29. Channel separation	NR SYSTEM sw.: dbx BIAS, EQ: Co(CrO ₂) Tape: MTT-5061	<ul style="list-style-type: none"> • Connection: Fig. 5-1, but do not connect LINE IN (R), and engage 1-kHz filter. • Set the deck to record mode. Find the difference between the 1-kHz recorded portion (L-ch) and the "no signal" portion (R-ch). 			
		LINE IN: L-ch: 1 kHz/-9 dB (275 mV) R-ch: No signal	Check	OUTPUT: 60 dB min. ratio	
30. Distortion	RECORD-PLAY mode BIAS, EQ: METAL Tape: MTT-5072 BIAS, EQ: Co(CrO ₂) Tape: MTT-5061 BIAS, EQ: NORMAL Tape: MTT-501	LINE IN: 400 Hz/-12 dB (195 mV)	Check	OUTPUT: 1.5% or less (using 3 different types of test tapes)	
		LINE IN: 1 kHz/-9 dB (275 mV) No signal	Check	OUTPUT: 65 dB min. ratio (using 3 different types of test tapes)	Ratio of 1 kHz output (-5 dB) to noise

5-5 ADJUSTMENT AND TEST POINT LOCATIONS (1)

NOTE: Adjustor locations for DBX PERFORMANCE and for PCB ADJUSTMENT (5-6) are provided separately. See page 15.

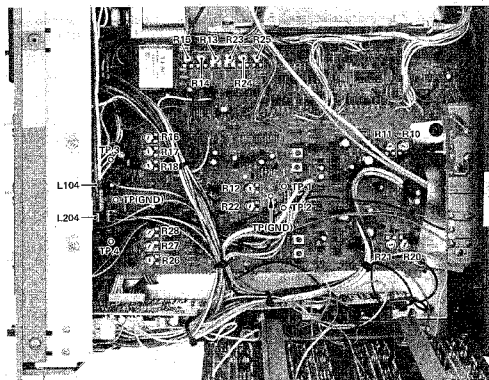

Fig. 5-9

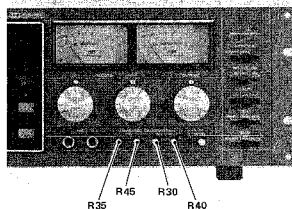

Fig. 5-10

R10/R20	Playback EQ
R11/R21	Playback level
R12/R22	PEAK LEVEL meter
R13/R23	Record bias (NORMAL)
R14/R24	Record bias [Co(CrO ₂)]
R15/R25	Record bias (METAL)
R16/R26	Record level (METAL)
R17/R27	Record level [Co(CrO ₂)]
R18/R28	Record level (NORMAL)
R30/R40	Record level (course-adjusted for general setting)
R35/R45	Record bias (course-adjusted for general setting)
L104/L204	Bias trap

5-6 DBX PCB ADJUSTMENT

NOTES:

1. This section adjustment is not usually needed unless any of adjuster(s) have been changed or any component(s) on the PCB have sustained damage, since both the ENCODER and DECODER sections have been precisely adjusted in the factory.
2. For this section adjustment, it is necessary to unsolder the wires from terminals A, C, B, D, F, I, H, and J on the dbx PCB. Turn the deck OFF to prevent accidental damage when unsoldering or resoldering.

3. Simply press the POWER switch to ON (all other switches and controls on the deck have no effect on this adjustment), then make this section adjustment.
4. The measurement equipment's GND (0 V) terminal should be connected to the dbx PCB's E terminal, except in steps 2 and 3, and 6 to 8 in both the ENCODER and DECODER adjustments.

5-7 ADJUSTMENT AND TEST POINT LOCATIONS (2)

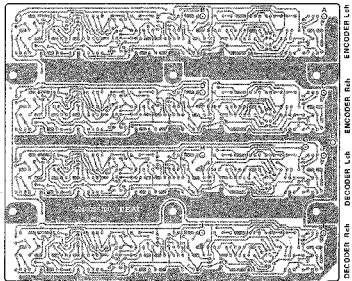
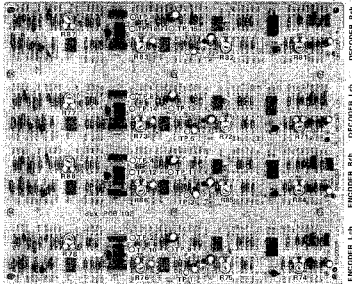

Fig. 5-11

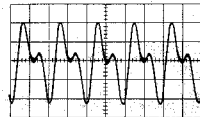

Fig. 5-12 R78/R88 and R77/R87 settings (Incorrect)

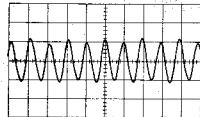

Fig. 5-13 R78/R88 and R77/R87 settings (Correct)

5-6-1 ENCODER ADJUSTMENT

1. Preset all adjustors approximately to the center position.
2. Make the Fig. 5-14 connections, then feed 100 Hz, -8 dB (308 mV) to A/C (INPUT) terminal.
3. Adjust R78/R88 to obtain a clear 200 Hz sine-wave on the oscilloscope. See Fig's 5-12 and 5-13.
4. Change the connections to Fig. 5-15, then feed a 1 kHz -8 dB (308 mV) input signal to the INPUT terminal. Adjust R76/R86 so that AC voltmeter reads -8 dB (308 mV).
5. With the conditions in step 4, adjust R74/R84 for minimum distortion (0.1% or less).
6. Like Fig. 5-16, connect a DC voltmeter between TP1 and TP9 for L-ch (or TP3 and TP11 for R-ch), then note the reading on the DC voltmeter with an input signal of 1 kHz -8 dB (308 mV).
7. Cut off the input signal, then make the same measurement as in step 6 to adjust R75/R85 for the same level.

8. Repeat above steps 5 to 7 until the best results are obtained.
9. Check that when the input signal is 100 Hz -8 dB (308 mV), then 10 kHz -8 dB, the output signal from B/D (OUTPUT) terminal deviates by $+0.5$ dB ± 0.5 dB, then -2.8 dB ± 0.5 dB from -8 dB (reference), 308 mV to 346 mV for 100 Hz, and 211 mV to 237 mV for 10 kHz.
10. Check that when 1 kHz -66 dB (308 μ V) is applied, the output is -38 dB ± 0.5 dB (9.21 mV to 10.3 mV).
11. Check that when the input signal is 1 kHz, $+12$ dB (3.08 V), the output is $+2$ dB ± 0.5 dB (0.921V to 1.03V) and distortion factor is 0.3% or less.

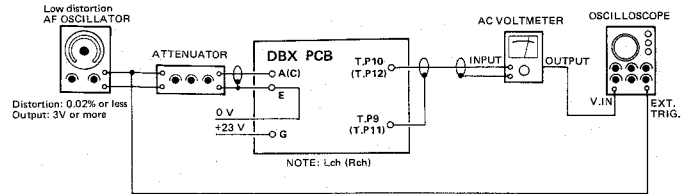

Fig. 5-14 Connections for ENCODER adjustment (1)

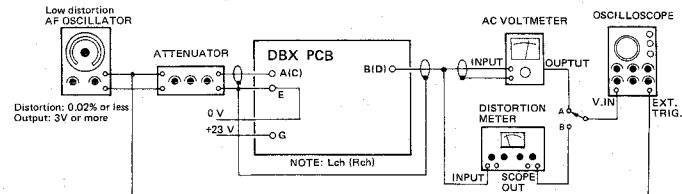

Fig. 5-15 Connections for ENCODER adjustment (2)

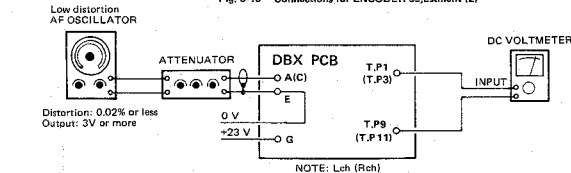

Fig. 5-16 Connections for ENCODER adjustment (3)

5-6-2 DECODER ADJUSTMENT

1. Preset all adjustors approximately to the center position.
2. Make the Fig. 5-17 connections, then feed 100 Hz, -8 dB (308 mV) to the F/I (INPUT) terminal.
3. Adjust R77/R87 to obtain a clear 200 Hz sine-wave on the oscilloscope. See Fig's 5-12 and 5-13.
4. Change the connections to Fig. 5-18, then feed a 1 kHz/-8 dB (308 mV) input signal to the INPUT terminal. Adjust R73/R83 so that AC voltmeter reads -8 dB (308 mV).
5. With the conditions in step 4, adjust R71/R81 for minimum distortion (0.1% or less).
6. Like Fig. 5-19, connect a DC voltmeter between TP5 and TP13 for L-ch (or TP7 and TP15 for R-ch), then note the reading on the DC voltmeter with an input signal of 1 kHz/-8 dB (308 mV).
7. Cut off the input signal, connect TP6/TP8 to the E (0 V) terminal, then make the same measurement as in step 6 to adjust R72/R82 for the same level.
8. Repeat above steps 5 to 7 until the best results are obtained.
9. Check that when the input signal is 100 Hz/-8 dB (308 mV), then 10 kHz/-8 dB, the output signal from H/J (OUTPUT) terminal deviates by $-1 \text{ dB} \pm 0.5 \text{ dB}$, then $+5.5 \text{ dB} \pm 0.5 \text{ dB}$ from -8 dB (reference), respectively ... so that output, as a voltage value, should be 652 mV to 731 mV for 100 Hz, and 1.38 V to 1.55 V for 10 kHz.
10. Check that when 1 kHz/-38 dB (9.75 mV) is applied, the output is $-68 \text{ dB} \pm 1 \text{ dB}$ (275 μV to 346 μV).
11. Check that when the input signal is 1 kHz, +2 dB (0.975 V), the output is $+12 \text{ dB} \pm 1 \text{ dB}$ (2.75 V to 3.46 V) and the distortion factor is 0.3% or less.

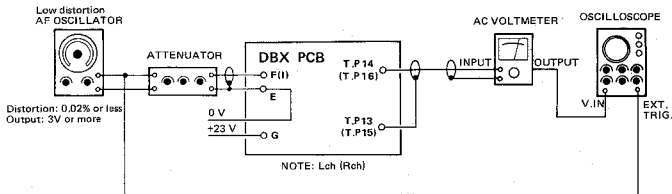

Fig. 5-17 Connections for DECODER adjustment (1)

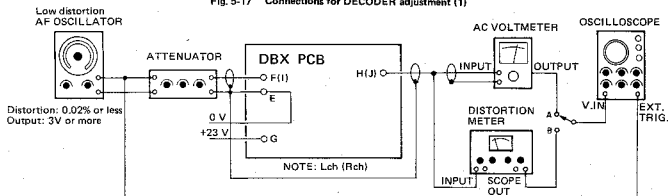

Fig. 5-18 Connections for DECODER adjustment (2)

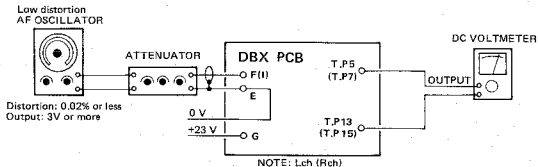

Fig. 5-19 Connections for DECODER adjustment (3)

EXPLODED VIEW - 1

Parts marked with *require longer delivery time.

REF. NO.	PARTS NO.	DESCRIPTION	REMARKS
1 - 1	*5800060300	Cover, Top [All except L]	C-3X
1 - 2	*5122225000	Connector, Socket; 6P (BLK)	
1 - 3	*5122222000	Connector, Socket; 3P (BLK)	
1 - 4	*5555570000	Cushion; Top Cover; B	
1 - 5	*5122172000	Connector, Socket; 10P (WHT)	
1 - 6	*5122167000	Connector, Socket; 5P (WHT)	
1 - 7	*5800059401	Bracket, Handle; BL	C-3X
1 - 8	*5800083400	Escutcheon Assy, Cassette	C-3X
1 - 9	*5122174000	Connector, Socket; 12P (WHT)	
1 - 10	*5785603025	Spacer	
1 - 11	5504712000	Knob Assy, TIMER	C-3
1 - 12	*5640018600	Panel Assy, Front	C-1
1 - 13	5543027100	Knob, VR	C-1
1 - 14	5534521000	Knob, Lever Switch	A-500
1 - 15	*5552340202	Chassis, Rear [All except L]	
	*5502229002	Chassis Assy, Rear [L]	
1 - 16	*5504676000	Foot [All except L]	A-500
1 - 17	*5800059501	Bracket, Handle; BR	C-3X
1 - 18	*5800064800	Cabinet Assy [L]	C-3X
1 - 19	*5555526000	Washer [L]	
1 - 20	*5800060400	Cover, Top; Shield [L]	C-3X
1 - 21	*5800059800	Sash, Side; L [L]	
1 - 22	*5800059900	Sash, Side; R [L]	
1 - 23	5138009000	Key Unit	122
1 - 24	5800133600	Cover Assy, Cassette	

INCLUDED ACCESSORIES

Parts marked with *require longer delivery time.

REF. NO.	PARTS NO.	DESCRIPTION	REMARKS
	5128065000	Cord Assy, Input-output Connection	
	5101345000	Information Supplement, Cassette [U]	
	5101495000	Information Supplement, Cassette [All except L]	C-3X
	5740005000	Plate Assy, Side; B [All except L]	C-1
	5544995000	Washer x 4 [All except L]	
	5534659000	Spacer x 4 [All except L]	C-1
	5780215015	Screw, M5 x 15 (Ni) x 4 [All except L]	
	5564682000	Seal, MEMORY [All except L]	C-3
	5700014800	C-3RX Owner's Manual [U]	
	5700014900	C-3RX Owner's Manual [All except U]	

[U]: U.S.A.
[A]: AUSTRALIA
[L]: LIMITED AREA

[C]: CANADA
[E]: EUROPE

[GE]: GENERAL EXPORT
[UK]: U.K.

EXPLODED VIEW - 2

Parts marked with *require longer delivery time.

REF. NO.	PARTS NO.	DESCRIPTION	REMARKS
2 - 1	*5553285001	Holder, Cassette	C-3
2 - 2	*5544955000	Shaft, Lock Plate	A-500
2 - 3	*5534612000	Plate, Lock	A-500
2 - 4	5534613000	Guide, Cassette; L	A-500
2 - 5	*5555655000	Plate, Cassette Holder	C-3
2 - 6	*5534615000	Spring, Cassette Pressure	A-500
2 - 7	*5555582000	Tape, Adhesive	A-300
2 - 8	*5534638000	Lens, Lamp	A-300
2 - 9	5534644000	Shoe, Brake	A-420
2 - 10	*5520333000	Spring, Brake	A-300
2 - 11	*5504669002	Plate Assy, Brake; B	A-500
2 - 12	*5210010200	PCB, LAMP [U]	C-3X
	*5210022400	PCB, LAMP [All except U]	C-3X
2 - 13	5142026000	Lamp, DC 6V 65mA	
2 - 14	*5544656000	Shaft, Lever	A-300
2 - 16	*5555544000	Lever, Record Preventing; D	A-500
2 - 16	*5524197000	Spring, Lever	A-500
2 - 17	*5555535000	Bracket, Counter Assy	A-500
2 - 18	5504660001	Counter Assy	A-500
2 - 19	5534617000	Belt, Counter	A-500
2 - 20	*5534448000	Mounting Rubber	A-300
2 - 21	*5200018410	PCB Assy, REED SW [All except U]	C-3X
	*5200018400	PCB Assy, REED SW [U]	C-3X
2 - 22	*5534444200	Guide, Cassette	A-300
2 - 23	*5524201000	Spring, Eject Arm	A-500
2 - 24	*5555551000	Arm, Eject	A-500
2 - 25	*5800090800	Holder Assy, Switch	C-3X
2 - 26	*5800098500	Cushion, Reel	C-3X
2 - 27	*5555552000	Arm, Eject Actuating	A-500
2 - 28	5800063800	Pulley Assy, Reel; R	C-3X
2 - 29	*5581055000	Screw, Shoulder	
2 - 30	5800063700	Pulley Assy, Reel; L	C-3X
2 - 31	*5555549000	Arm, Eject Preventing	A-500
2 - 32	*5524200000	Spring, Arm	A-500
2 - 33	*5534606000	Arm, Pinch Roller	A-500
2 - 34	5504828001	Arm Assy, Pinch Roller	C-3
2 - 35	*5800060100	Chassis Assy, Mechanism	
2 - 36	*5524285000	Spring, Pinch Roller	C-3
2 - 37	*5555531000	Plate, Head Base; B	A-500
2 - 38	*5555530000	Plate, Head Base; A	
2 - 39	*5504717000	Plate Assy, Head Base	C-3
2 - 40	*5581052000	Clamper, Cord; E	
2 - 41	*5540055000	Steel Ball, ø2	A-450
2 - 42	*5555533000	Plate, Pressure	A-500
2 - 43	*5800064400	Spacer, Erase Head	C-3X
2 - 44	5569613000	Head, Erase	C-3
2 - 45	*5524141000	Spring, Height Adj.	C-1
2 - 46	*5524208000	Spring, Tension	A-300
2 - 47	*5533174000	Arm, Tension	A-300
2 - 48	*5540056000	Steel Ball, ø3	A-450
2 - 49	5800063300	Table Assy, Reel; R	C-3X
2 - 50	5800063200	Table Assy, Reel; L	C-3X
2 - 51	*5534663100	Guide, Cassette; L	C-3
2 - 52	*5504716000	Plate Assy, Head Mounting	C-3
2 - 53	*5555658000	Plate, Tension Adj.	C-3
2 - 54	5569606100	Head, REC-PLAY	C-2
2 - 55	5534614000	Guide, Cassette; R	A-500
2 - 56	*5504714000	Bracket Assy, Holder; L	C-3
2 - 57	*5504715000	Bracket Assy, Holder; R	C-3
2 - 58	*5524202000	Spring, Holder	
2 - 59	*5581038000	Clamper, Cord; A	

[U]: U.S.A.
[A]: AUSTRALIA
[L]: LIMITED AREA

[C]: CANADA
[E]: EUROPE

[GE]: GENERAL EXPORT
[UK]: U.K.

EXPLODED VIEW - 3

Parts marked with *require longer delivery time.

REF. NO.	PARTS NO.	DESCRIPTION	REMARKS
3 - 1	*5504673000	Holder Assy, Damper; C	A-500
3 - 2	*5555655000	Bracket, Damper	A-500
3 - 3	5370001700	Motor Assy, Capstan; DC	C-3X
3 - 4	*5800064601	Plate, Flywheel Base	A-400
3 - 5	*5534277000	Bearing, Flywheel	
3 - 6	*5200014120	PCB Assy, JOINT [U]	
	*5200014130	PCB Assy, JOINT [All except U]	
3 - 7	5504757000	Flywheel Assy, Capstan	A-210
3 - 8	5163040000	Solenoid, B	
3 - 9	5163039100	Solenoid, A	
3 - 10	5313000500	Solenoid	C-3X
3 - 11	*5555546000	Arm, Pressure; B	A-500
3 - 12	*5581038000	Clamper, Cord; A	
3 - 13	*5800062600	Lever, Actuating	C-3X
3 - 14	*5524195000	Spring, Lever	A-500
3 - 15	*5504666000	Lever Assy, Pause Actuating	A-500
3 - 16	*5534611000	Arm, Pause Actuating	A-500
3 - 17	*5800061900	Arm Assy, Actuating	C-3X
3 - 18	*5504665000	Lever Assy, Actuating	A-500
3 - 19	*5524213000	Spring, Actuating; A	A-500
3 - 20	*5800065500	Bracket Assy, Solenoid; B	C-3X
3 - 21	*5555543000	Bracket, Switch	A-500
3 - 22	5301455500	Switch, Micro	
3 - 23	*5534610000	Arm, Base Actuating	A-500
3 - 24	*5800062700	Spring, Pulley Guide	C-3X
3 - 25	*5800062900	Plate, Pulley Guide	C-3X
3 - 26	*5504667000	Lever Assy, Pause	A-500
3 - 27	*5524203000	Spring, Damper	A-500
3 - 28	*5788202100	String, Damper	
3 - 29	*5555556000	Angle, Spring	A-500
3 - 30	*5800060100	Chassis Assy, Mechanism	
3 - 31	*5800062300	Bracket, Switch	C-3X
3 - 32	*5800062800	Spring, Cassette Pressure	C-3X
3 - 33	*5800061600	Arm, Cassette Pressure	C-3X
3 - 34	*5504670000	Lever Assy, Eject	A-500
3 - 35	*5524199000	Spring, Eject	A-500
3 - 36	*5800063000	Guide, Actuating Bar	C-3X
3 - 37	*5800062500	Bar, Brake Actuating	C-3X
3 - 38	*5534130000	Washer, Oil Retaining	A-400
3 - 39	5504091000	Housing Assy, Capstan	A-170
3 - 40	*5550031000	Washer Thrust	A-450
3 - 41	5504808000	Pulley Assy, Fast Wind	C-2
3 - 42	*5524274000	Spring, Arm	C-2
3 - 43	5800063100	Belt, Capstan Drive	C-3X
3 - 44	*5545144000	Pulley, Motor	C-2
3 - 45	*5504807001	Plate Assy, Motor	C-2
3 - 46	7105135000	Motor Assy, Reel; DC	C-2
3 - 47	*5534537000	Collar, Rubber	A-206
3 - 48	*5800102100	Angle, Base	C-3X
3 - 49	5130003000	Switch, Micro	

[U]: U.S.A.
 [A]: AUSTRALIA
 [L]: LIMITED AREA

[C]: CANADA
 [E]: EUROPE

[GE]: GENERAL EXPORT
 [UK]: U.K.

EXPLODED VIEW - 4

Parts marked with *require longer delivery time.

REF. NO.	PARTS NO.	DESCRIPTION	REMARKS
4 - 1	△5128034000	Cord, AC Power [GE, L]	
	△5128075000	Cord, AC Power [U, C]	
	△5128017000	Cord, AC Power [E]	
	△5128036000	Cord, AC Power [UK]	
	△5350008300	Cord, AC Power [A]	
4 - 2	*5534660000	Strain Relief, AC Power Cord [All except UK]	
	*5534661000	Strain Relief, AC Power Cord [UK]	
4 - 3	*5534118000	Rivet, Push	A-400
4 - 4	*5552339000	Panel, Rear	A-500
4 - 5	*5555570000	Cushion, Top Cover; B	
4 - 6	*5200013500	PCB Assy, REMOTE [U]	C-3X
	*5200013510	PCB Assy, REMOTE [All except U]	C-3X
4 - 7	*5200013400	PCB Assy, IN/OUTPUT [U]	C-3X
	*5200013410	PCB Assy, IN/OUTPUT [All except U]	C-3X
4 - 8	*5122167000	Connector, Socket; 5P (WHT)	
4 - 9	*5200035100	PCB Assy, DBX	
4 - 10	*5555981000	Bracket, B; DBX PCB	
4 - 11	*5800146200	Bracket, L; DBX PCB	
4 - 12	*5800088000	Cover, Shield	C-3X
4 - 13	*5122225000	Connector, Socket; 6P (BLK)	
4 - 14	*5122223000	Connector, Socket; 4P (BLK)	
4 - 15	*5122284000	Connector, Socket; 6P (RED)	
4 - 16	*5555565200	Angle, PCB	A-500
4 - 17	*5122282000	Connector, Socket; 4P (RED)	
4 - 18	*5122166000	Connector, Socket; 4P (WHT)	
4 - 19	*5200013140	PCB Assy, REC-PLAY AMPL [U]	
	*5200013150	PCB Assy, REC-PLAY AMPL [All except U]	
4 - 20	*5122165000	Connector, Socket; 3P (WHT)	
4 - 21	*5122169000	Connector, Socket; 7P (WHT)	
4 - 22	*5581038000	Clamper, Cord; A	
4 - 23	*5122164000	Connector, Socket; 2P (WHT)	
4 - 24	5150223000	Var. Res., 100kΩ (A)	
4 - 25	*5282406302	Var. Res., 20kΩ x 2 (A)	
4 - 26	5282250201	Var. Res., 250kΩ (B)	
4 - 27	5282250101	Var. Res., 50kΩ (B)	
4 - 28	5300019500	Switch, Push; 6-2	
4 - 29	5504713000	Knob, Push Switch; K	C-3
4 - 30	*5122168000	Connector, Socket; 6P (WHT)	
4 - 31	*5200013201	PCB Assy, MIC JACK [U]	C-3X
	*5200013211	PCB Assy, MIC JACK [All except U]	C-3X
4 - 32	*5504710001	Bracket, Var. Res.	C-3
4 - 33	5504588000	Gear Assy, A	C-1
4 - 34	*5504589200	Gear Assy, Friction	C-1
4 - 35	*5200038400	PCB Assy, LED	
4 - 36	*5168899000	PCB Assy, LED	
4 - 37	*5524082000	Spring, LED; B	AL-700
4 - 38	*5336041000	Connector, Socket; 10P (WHT)	
4 - 39	*5336040800	Connector, Socket; 8P (WHT)	
4 - 40	*5555913000	Mask, C	
4 - 41	*5534473000	Rivet, T-type	A-5
4 - 42	*5200035300	PCB Assy, SW	
4 - 43	*5581056000	Screw, Shoulder; A	A-304
4 - 44	*5800146300	Bracket, R; DBX PCB	
4 - 45	*5553269101	Chassis, L	A-500
4 - 46	*5555646000	Bracket, Lever Switch	C-3
4 - 47	*5555912000	Mask, B	
4 - 48	*5786615100	Rivet, Push	
4 - 49	*5800146100	Cover, LED	
4 - 50	5296002000	Meter, Peak Level	
4 - 51	*5554653200	Bracket, Meter	A-650

(Continued on page 38)

[U]: U.S.A.
[A]: AUSTRALIA
[L]: LIMITED AREA

[C]: CANADA
[E]: EUROPE

[GE]: GENERAL EXPORT
[UK]: U.K.

REC/PLAY AMPL PCB ASSY

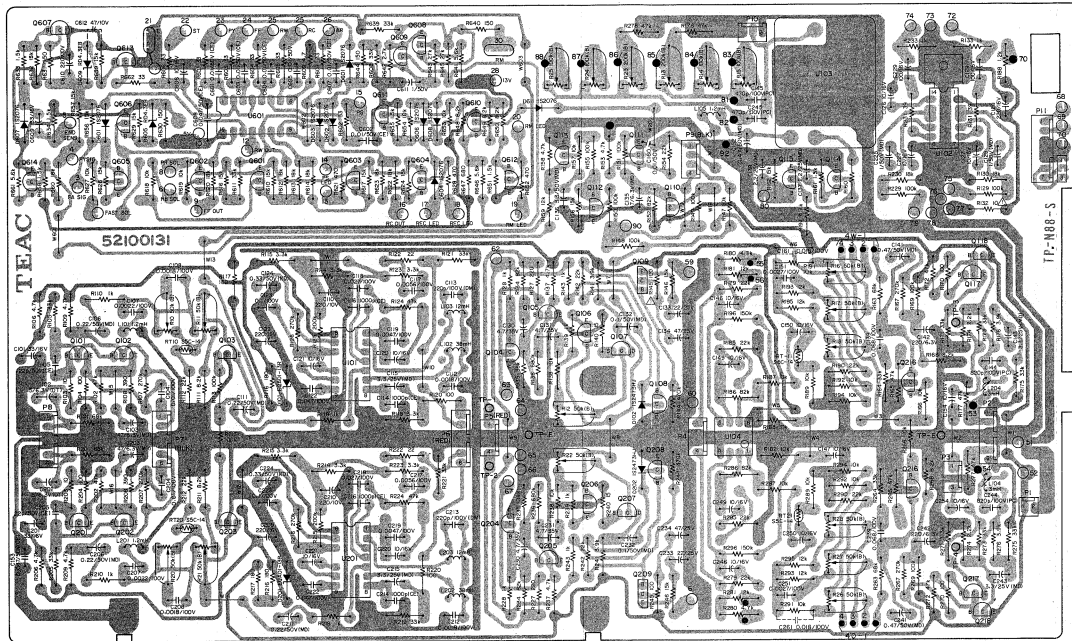

NOTES

1. PC Boards shown viewed from foil side.
2. The colors used on the PCB illustrations have the following significance:
 : +B power supply circuit
 : GND
 : Other
3. Resistor values are in ohms (k = 1,000 ohms).
4. All capacitor values are in microfarads (μ = picofarads).

POWER SUPPLY PCB ASSY

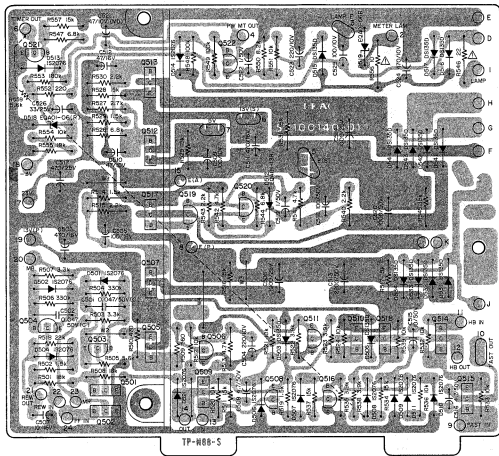

MIC JACK PCB ASSY

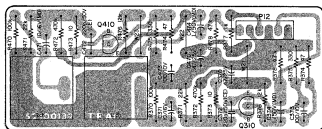

JOINT PCB ASSY

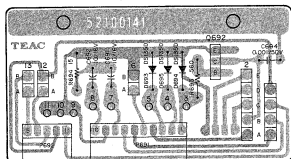

DBX PCB ASSY

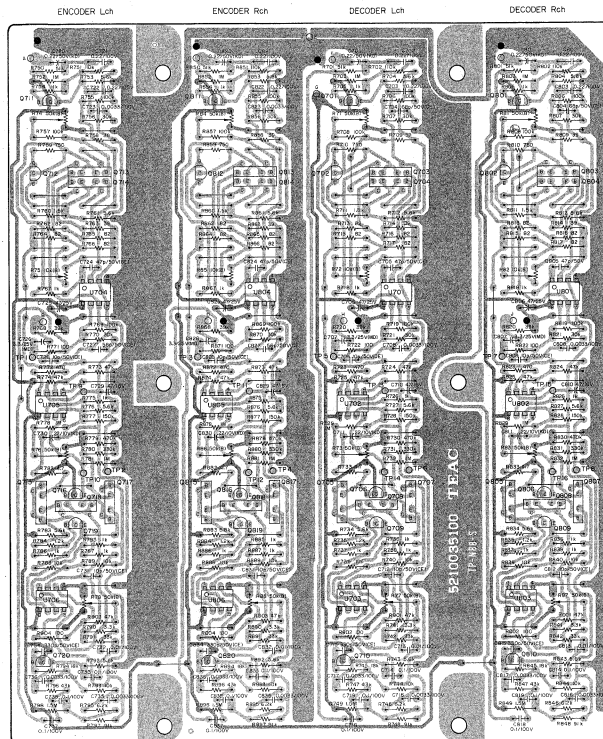

LEVER SWITCH PCB ASSY

REF. NO.	PARTS NO.	DESCRIPTION
	5200035300	PCB Assy
	5210035300	PCB
	IC's	
U301, U401	5147040000	NE645B
	TRANSISTORS	
Q301, Q401	5145178000	2SC1684S
Q302, Q402	5145178000	2SC1684S
	CARBON RESISTORS	
All resistors are rated +5% tolerance and 1/4 watt.		
R302, R402	5183098000	4.7k Ω
R304, R404	5183096000	3.9k Ω
R305, R405	5183070000	330 Ω
R306, R306	5183070000	330 Ω
R307, R407	5183094000	3.3k Ω
R308, R408	5183094000	3.3k Ω
R309, R409	5183082000	1k Ω
R310, R410	5183058000	100 Ω
R311, R411	5183118000	33k Ω
R312, R412	5183058000	100 Ω
R313, R413	5183118000	33k Ω
R314, R414	5183118000	33k Ω
R315, R415	5183042000	22 Ω
R316, R416	5183094000	3.3k Ω
R317, R417	5183122000	47k Ω
R318, R418	5183137000	200k Ω
R320, R420	5183140000	270k Ω
R330	5183096000	4.7k Ω
R340	5183098000	4.7k Ω
R341	5183130000	100k Ω
R355, R455	5183060000	120 Ω
R356, R456	5183054000	68 Ω
R357, R457	5183056000	82 Ω
R359, R459	5183128000	82k Ω
R360, R460	5183102000	6.8k Ω
R361, R461	5183128000	82k Ω
R362, R462	5183098000	4.7k Ω
R365, R366	5183080000	820 Ω
	CAPACITORS	
C301, C401	5173054800	Elec. 220 μ F 16V
C302, C402	5173053800	Elec. 220 μ F 10V
C303, C403	5173733000	Polypro. 0.0012 μ F 100V 5%
C304, C404	5173553800	Elec. 0.33 μ F 50V
C305, C405	5173735000	Polypro. 0.0018 μ F 100V 5%
C306, C406	5172324000	Ceramic 0.001 μ F 50V 10%
C307, C407	5173551800	Elec. 3.3 μ F 25V
C308, C408	5172324000	Ceramic 0.001 μ F 50V 10%
C309, C409	5172551800	Elec. 3.3 μ F 25V
C310, C410	5170419000	Mylar 0.0056 μ F 100V 5%
C311, C411	5170435000	Mylar 0.027 μ F 100V 5%
C312, C412	5170417000	Mylar 0.0047 μ F 100V 5%
C313, C413	5173010800	Elec. 10 μ F 16V
C314, C414	5173010800	Elec. 10 μ F 16V
C315, C415	5170441000	Mylar 0.047 μ F 100V 5%

REF. NO.	PARTS NO.	DESCRIPTION
C316, C416	5170449000	Mylar 0.1 μ F 100V 5%
C317, C417	526225812	Elec. 0.33 μ F 50V 10%
C331, C431	5170427000	Mylar 0.012 μ F 100V 5%
C332, C432	5170427000	Mylar 0.012 μ F 100V 5%
C333, C433	5170425000	Mylar 0.01 μ F 100V 5%
C334, C434	5170429000	Mylar 0.015 μ F 100V 5%
C335, C435	5170423000	Mylar 0.0082 μ F 100V 5%
	COILS	
L301, L401	5286003500	Choke, 8mH; Variable
	SWITCHES	
S1	5132046000	Lever, 2 - 2
S2	5300513100	Lever, 10 - 3
S3	5132043000	Lever, 4 - 3
S5	5300512700	Lever, 10 - 3
S6	5132043000	Lever, 4 - 3
	MISCELLANEOUS	
U305, U405	5292802600	Filter, Low-pass

REC-PLAY AMPL PCB ASSY

REF. NO.	PARTS NO.	DESCRIPTION
	5200013140	PCB Assy [U]
	5200013150	PCB Assy [All except U]
	5210013100	PCB [U]
	5210021200	PCB [All except U]
IC's		
U101, U201	5147040000	NE645B
U102	5147074000	LA4170
U104	5147024000	JRC4558DF
U601	5147047000	MS4410P
TRANSISTORS		
Q101, Q201	5146119000	2SC1844F
Q102, Q202	5042461000	2SC1327T
Q103, Q203	5145195000	2SD655E
Q104, Q204	5145086000	2SC1636-2
Q105, Q205	5042461000	2SC1327T
Q106, Q206	5145178000	2SC1684S
Q107, Q207	5145183000	FET, 2SK68AMI
Q108, Q208	5145086000	2SC1636-2
Q109, Q209	5145110000	2SC1637-1
Q110	5145132000	2SA933LNS
Q111	5145178000	2SC1684S
Q112	5145132000	2SA933LNS
Q113	5145178000	2SC1684S
Q114	5145082000	2SC2060Q
Q115	5145178000	2SC1684S
Q116, Q216	5145185000	2SD655E
Q117, Q217	5145178000	2SC1684S
Q118, Q218	5145132000	2SA933LNS
Q601, Q602	5230770700	2SC1841E
Q603, Q604	5145091000	2SC945AK
Q605	5230770700	2SC1841E
Q606~Q609	5145091000	2SC945AK
Q610	5042553000	2SA733P
Q611~Q614	5145091000	2SC945AK
DIODES		
D101, D201	5143195000	Zener, EQA01-13RF
D102, D202	5143118000	1S2473HJ
D601~D604	5224012510	1S2076
D605	5143143000	Zener, RD4.3E
D606~D608	5224012510	1S2076
D609	5143143000	Zener, RD4.3E
D610, D611	5224012510	1S2076
CARBON RESISTORS		
All resistors are rated ±5% tolerance and ½ watt.		
R101, R201	5183128000	68kΩ
R102, R202	5183122000	47kΩ
R103, R203	5183034000	10Ω
R104, R204	5183058000	100Ω
R105, R205	5183118000	33kΩ
R106, R206	5183098000	4.7kΩ
R107, R207	5183140000	270kΩ
R108, R208	5183072000	390Ω
R109, R209	5183098000	4.7kΩ
R110, R210	5183082000	1kΩ
R111, R211	5183104000	8.2kΩ
R112, R212	5183114000	22kΩ
R113, R213	5183130000	100kΩ
R114, R214	5183094000	3.3kΩ
R115, R215	5183094000	3.3kΩ

REF. NO.	PARTS NO.	DESCRIPTION
R116, R216	5183064000	180Ω
R117, R217	5183064000	180Ω
R118, R218	5183082000	1kΩ
R119, R219	5183118000	33kΩ
R120, R220	5183058000	100Ω
R121, R221	5183118000	33kΩ
R122, R222	5183042000	22Ω
R123, R223	5183094000	3.3kΩ
R124, R224	5183122000	47kΩ
R125, R225	5183137000	200kΩ
R126, R226	5183140000	270kΩ
R127, R227	5183066000	220Ω
R128, R228	5183082000	1kΩ
R129, R229	5183130000	100kΩ
R130, R230	5183112000	18kΩ
R131, R231	5183048000	39Ω
R132	△ 5184225000	10Ω, Non Flammable
R133, R233	5183092000	1kΩ
R134, R234	5183128000	82kΩ
R135, R235	5183120000	39kΩ
R136, R236	5183150000	680kΩ
R137, R237	5183098000	4.7kΩ
R138, R238	5183106000	10kΩ
R139, R239	5183082000	1kΩ
R140, R240	5183038000	15Ω
R141, R241	5183096000	3.9kΩ
R142, R242	5183114000	22kΩ
R143, R243	5183082000	1kΩ
R144, R244	5183146000	470kΩ
R145, R245	△ 5184249000	100Ω, Non Flammable
R146, R246	5183110000	15kΩ
R147	5183108000	10kΩ
R148~R151	5183130000	100kΩ
R152	5183128000	82kΩ
R153	5183098000	4.7kΩ
R154	5183114000	22kΩ
R155	5183130000	100kΩ
R156	5183110000	15kΩ
R157	5183106000	10kΩ
R158	5183098000	4.7kΩ
R159	5183114000	22kΩ
R160	5183010000	1Ω
R161	5183086000	1.5kΩ
R162	5183110000	15kΩ
R163, R263	5183126000	68kΩ
R164, R264	5183118000	33kΩ
R165, R265	5183122000	47kΩ
R166, R266	5183106000	10kΩ
R167, R267	5183138000	220kΩ
R168, R268	5183104000	8.2kΩ
R169, R269	5183130000	100kΩ
R170, R270	5183098000	4.7kΩ
R171, R271	5183094000	3.3kΩ
R172, R272	5183122000	47kΩ
R173, R273	5183118000	33kΩ
R174, R274	5183090000	2.2kΩ
R175, R275	5183118000	33kΩ
R176, R276	5183096000	3.9kΩ
R177, R277	5183122000	47kΩ
R178, R278	5183122000	47kΩ
R179, R279	5183114000	22kΩ
R180, R280	5183098000	4.7kΩ
R181, R281	5183108000	12kΩ

[U]: U.S.A.
[A]: AUSTRALIA
[L]: LIMITED AREA

[C]: CANADA
[E]: EUROPE

[GE]: GENERAL EXPORT
[UK]: U.K.

REF. NO.	PARTS NO.	DESCRIPTION
R182, R183	5183106000	10k Ω
R185, R285	5183114000	22k Ω
R186, R286	5183128000	82k Ω
R187, R287	5183106000	10k Ω
R188	5183084000	1.2k Ω
R189, R289	5183106000	10k Ω
R190, R290	5183114000	22k Ω
R191, R291	5183106000	10k Ω
R192, R292	5183106000	10k Ω
R193, R293	5183108000	12k Ω
R194, R294	5183106000	10k Ω
R195, R295	5183108000	12k Ω
R196, R296	5183134000	150k Ω
R197	5183098000	4.7k Ω
R601~R607	5183046000	33 Ω
R608	5183118000	33k Ω
R609	5183026000	4.7 Ω
R610	5183110000	15k Ω
R611	5183118000	33k Ω
R612~R614	5183112000	18k Ω
R616, R617	5183110000	15k Ω
R618, R619	5183106000	10k Ω
R620	5183112000	18k Ω
R621	5183074000	470 Ω
R622, R623	5183112000	18k Ω
R624	5183110000	15k Ω
R625	5183080000	1.5k Ω
R627	5183108000	10k Ω
R628	5183074000	470 Ω
R629	5183110000	15k Ω
R630, R631	5183062000	150 Ω
R632	5183110000	15k Ω
R633, R634	5183080000	1.5k Ω
R639	5183118000	33k Ω
R640	5183062000	150 Ω
R641	5183100000	5.6k Ω
R642	5183092000	2.7k Ω
R643	5183116000	27k Ω
R644	5183062000	150 Ω
R645	5183116000	27k Ω
R646	5183100000	5.6k Ω
R647	5183078000	680 Ω
R648~R650	5183104000	8.2k Ω
R651	5183086000	1.5k Ω
R652	5183074000	470 Ω
R653, R654	5183106000	10k Ω
R655	5183080000	1.5k Ω
R656, R657	5183110000	15k Ω
R658	5183086000	1.5k Ω
R659	5183110000	15k Ω
R660	5183112000	18k Ω
R661	5183100000	5.6k Ω
R662	5183046000	33 Ω
CAPACITORS		
C101, C201	5173027800	Elec. 33 μ F 16V
C102, C202	5171684000	Dip. Tant. 15 μ F 6.3V
C103, C203	5173587800	Elec. 47 μ F 6.3V
C104, C204	5170426000	Mylar 0.01 μ F 100V 5%
C105, C205	5172304000	Ceramic 22pF 50V 10%
C106, C206	5173552800	Elec. 0.22 μ F 50V
C107, C207	5170409000	Mylar 0.0022 μ F 100V 5%

REF. NO.	PARTS NO.	DESCRIPTION
C108, C208	5170401000	Mylar 0.0018 μ F 100V 5%
C109, C209	5173054800	Elec. 220 μ F 16V
C110, C210	5173053800	Elec. 220 μ F 10V
C111, C211	5173552800	Elec. 0.22 μ F 50V
C112, C212	5170407000	Mylar 0.0018 μ F 100V
C113, C213	5054745000	Dip. Mica 220pF 50V 10%
C114, C214	5172324000	Ceramic 0.001 μ F 50V
C115, C215	5173561800	Elec. 3.3 μ F 25V
C116, C216	5172324000	Ceramic 0.001 μ F 50V 10%
C117, C217	5170419000	Mylar 0.0056 μ F 100V 5%
C118, C218	5170435000	Mylar 0.027 μ F 100V 5%
C119, C219	5170417000	Mylar 0.0047 μ F 100V 5%
C120, C220	5173010800	Elec. 10 μ F 16V
C121, C221	5173010800	Elec. 10 μ F 16V
C122, C222	5170441000	Mylar 0.047 μ F 100V 5%
C123, C223	5170449000	Mylar 0.1 μ F 100V 5%
C124, C224	5260225812	Elec. 0.33 μ F 50V 10%
C125, C225	5173556800	Elec. 1 μ F 50V
C126	5173010800	Elec. 10 μ F 16V
C127, C227	5173010800	Elec. 10 μ F 16V
C128	5173054800	Elec. 220 μ F 16V
C129, C229	5173044800	Elec. 100 μ F 10V
C130, C230	5173005800	Elec. 4.7 μ F 35V
C131, C231	5173005800	Elec. 4.7 μ F 35V
C132, C232	5173550800	Elec. 0.1 μ F 50V
C133, C233	5173019800	Elec. 22 μ F 25V
C134, C234	5173037800	Elec. 47 μ F 25V
C135	5173507800	Elec. 47 μ F 6.3V
C136	5173560800	Elec. 2.2 μ F 50V
C137	5173554800	Elec. 0.47 μ F 50V
C138	5173560800	Elec. 2.2 μ F 50V
C139, C239	5170455000	Mylar 0.068 μ F 100V 5%
C141, C241	5173554800	Elec. 0.47 μ F 50V
C142, C242	5173052800	Elec. 220 μ F 6.3V
C143, C243	5173481800	Elec. 3.3 μ F 25V
C144, C244	5173731000	Polypro. 820pF 100V 5%
C145, C245	5173728000	Polypro. 470pF 100V 5%
C146, C246	5173010800	Elec. 10 μ F 16V
C147	5173010800	Elec. 10 μ F 16V
C149, C249	5173010800	Elec. 10 μ F 16V
C150, C250	5173010800	Elec. 10 μ F 16V
C151, C251	5170411000	Mylar 0.0027 μ F 100V 5%
C152	5173550800	Elec. 0.1 μ F 50V
C153	5172344000	Ceramic 0.047 μ F 50V 10%
C154, C254	5173010900	Elec. 10 μ F 16V
C161, C261	5170431000	Mylar 0.018 μ F 100V 5%
C601~C605	5172336000	Ceramic 0.01 μ F 50V 10%
C606	5173010800	Elec. 10 μ F 16V
C607	5172336000	Ceramic 0.01 μ F 50V 10%
C608	5054230000	Ceramic 0.047 μ F 50V 10%
C609	5173027800	Elec. 33 μ F 16V
C610	5173053800	Elec. 220 μ F 10V
C611	5172992800	Elec. 1 μ F 50V
C612	5173035800	Elec. 47 μ F 10V
THERMISTORS		
RT10, RT20	5143127000	S5C14
RT11, RT21	5143127000	S5C14
VARIABLE RESISTORS		
R10, R20	5280004002	Semi-fixed 50k Ω (B)
R11, R21	5280004002	Semi-fixed 50k Ω (B)

POWER SUPPLY PCB ASSY

REF. NO.	PARTS NO.	DESCRIPTION
R12, R22	5280004002	Semi-fixed 50kΩ(B)
R13, R23	5280004302	Semi-fixed 200kΩ(B)
R14, R24	5280004202	Semi-fixed 100kΩ(B)
R15, R25	5280004202	Semi-fixed 100kΩ(B)
R16, R26	5280004002	Semi-fixed 50kΩ(B)
R17, R27	5280004002	Semi-fixed 50kΩ(B)
R18, R28	5280004002	Semi-fixed 50kΩ(B)
COILS		
L101, L201	5160107000	Choke, 1200μH
L102, L202	5286001100	Choke, 38mH
L103, L203	5286001200	Trap, 12mH
L104, L204	5286001000	Choke, 3.1mH; Variable
MISCELLANEOUS		
U103	5040101000	OSC unit, 100kHz
P1	5122126000	Connector Plug, 2P (WHT)
P2	5122130000	Connector Plug, 6P (WHT)
P3	5122127000	Connector Plug, 3P (WHT)
P4	5122128000	Connector Plug, 4P (WHT)
P5	5122301000	Connector Plug, 4P (RED)
P6	5122303000	Connector Plug, 6P (RED)
P7	5122187000	Connector Plug, 6P (BLK)
P8	5122130000	Connector Plug, 6P (WHT)
P9	5122185000	Connector Plug, 4P (BLK)
P10	5122127000	Connector Plug, 3P (WHT)
P11	5122131000	Connector Plug, 7P (WHT)

REF. NO.	PARTS NO.	DESCRIPTION
	5200014003	PCB Assy [U]
	5200014021	PCB Assy [C]
	5200014013	PCB Assy [All except U, C]
	5210014001	PCB [U]
	5210022101	PCB [All except U]
TRANSISTORS		
Q501, Q502	5231755500	2SD985
Q503, Q504	5145085000	2SA934R
Q505	5231755100	2SD880Y
Q506	5145091000	2SC945AK
Q507	△5231755500	2SD985
Q508	5042553000	2SA733P
Q509, Q510	5230505300	2SB750
Q511	5230770700	2SC1841E
Q512, Q513	△5231755500	2SD985
Q514, Q515	5230505300	2SB750
Q516	5230770700	2SC1841E
Q517	△5231755100	2SD880Y
Q518	5230505300	2SB750
Q519~Q521	5145091000	2SC945AK
Q522	5042553000	2SA733P
DIODES		
D501, D502	5224012510	1S2076
D503	5224013210	DS135D
D504, D505	5224012510	1S2076
D506	5224013210	DS135D
D507~D511	5224012510	1S2076
D512	5143198000	Zener, EQA01-13R
D513, D514	5224012510	1S2076
D515~D517	5224013210	DS135D
D518, D519	5143153000	Zener, EQA01-06R
D521	5224012510	1S2076
D531~D534	△5224013210	DS135D
D541~D544	△5224013210	DS135D
CARBON RESISTORS		
All resistors are rated +5% tolerance and 1/4 watt.		
R501	5183112000	18kΩ
R502	5183086000	1.5kΩ
R503	5183094000	3.3kΩ
R504	5183142000	330kΩ
R505	5183100000	5.6kΩ
R506	5183142000	330kΩ
R507	5183094000	3.3kΩ
R508	5183112000	18kΩ
R509	5183078000	560Ω
R510	5183074000	470Ω
R511	5183110000	15kΩ
R512	5183106000	10kΩ
R513	5183098000	4.7kΩ
R514	5183086000	1.5kΩ
R515	5183096000	2.2kΩ
R516, R517	5183110000	15kΩ
R518	5183114000	22kΩ
R519	5183086000	1.5kΩ
R520, R521	5183108000	10kΩ
R522, R523	5183096000	3.9kΩ
R524	5183106000	10kΩ
R525	5183110000	15kΩ
R526	5183102000	6.8kΩ
R527	5183092000	2.7kΩ
R528	5183110000	15kΩ

[U]: U.S.A.
[A]: AUSTRALIA
[L]: LIMITED AREA

[C]: CANADA
[E]: EUROPE

[GE]: GENERAL EXPORT
[UK]: U.K.

MIC JACK PCB ASSY

REF. NO.	PARTS NO.	DESCRIPTION
R529	5183096000	15k Ω
R530	5183096000	2.2k Ω
R531	5183110000	15k Ω
R532, R533	5183106000	10k Ω
R534	5183110000	15k Ω
R535	5183096000	3.9k Ω
R536	5183106000	10k Ω
R537	5183110000	15k Ω
R538	5183096000	3.9k Ω
R539	5183106000	10k Ω
R540	5183090000	2.2k Ω
R541, R542	5183098000	4.7k Ω
R543	5183090000	2.2k Ω
R544	5183102000	6.8k Ω
R545	5183110000	15k Ω
R546	Δ 5184233000	22 Ω , Non Flammable
R547	5183102000	6.8k Ω
R548, R549	5183130000	100k Ω
R550	5183104000	8.2k Ω
R551	5183106000	10k Ω
R552	5183066000	220 Ω
R553	5183138000	180k Ω
R554	5183106000	10k Ω
R555	5183112000	18k Ω
R556	Δ 5184225000	10 Ω , Non Flammable
R557	5183110000	15k Ω
R559	5183310000	5.6k Ω
CAPACITORS		
C501, C502	5064230000	Ceramic 0.047 μ F 50V 10%
C503	Δ 5173072800	Elec. 470 μ F 16V
C504	5173053800	Elec. 220 μ F 10V
C505	5173045800	Elec. 100 μ F 16V
C506	Δ 5173062800	Elec. 1000 μ F 25V
C507	5173010800	Elec. 10 μ F 16V
C508	5173006800	Elec. 4.7 μ F 50V
C509	Δ 5173044800	Elec. 100 μ F 10V
C510	5173035800	Elec. 47 μ F 10V
C511	Δ 5173072800	Elec. 470 μ F 16V
C512	5173038800	Elec. 47 μ F 16V
C513	Δ 5262000200	Elec. 2200 μ F 50V
C514	5173062800	Elec. 1000 μ F 25V
C515	5173013800	Elec. 10 μ F 50V
C516	5173006800	Elec. 4.7 μ F 50V
C517	Δ 5173073800	Elec. 470 μ F 25V
C518	5173048800	Elec. 100 μ F 50V
C519	5172992800	Elec. 1 μ F 50V
C520	Δ 5173064800	Elec. 1000 μ F 50V
C521	5173588800	Elec. 47 μ F 10V
C522	5172992800	Elec. 1 μ F 50V
C523	5173053800	Elec. 220 μ F 10V
C524	5173071800	Elec. 470 μ F 10V
C525	5173048800	Elec. 100 μ F 10V
C526	5173028800	Elec. 33 μ F 25V

REF. NO.	PARTS NO.	DESCRIPTION
	5200013201	PCB Assy [U]
	5200013211	PCB Assy [All except U]
	5210013200	PCB [U]
	5210021300	PCB [All except U]
TRANSISTORS		
Q310, Q410	5145119000	2SC1844F
CARBON RESISTORS		
All resistors are rated $\pm 5\%$ tolerance, $\frac{1}{4}$ watt.		
R370, R470	5183130000	100k Ω
R371, R471	5183114000	22k Ω
R372, R472	5183146000	470k Ω
R373, R473	5183034000	10 Ω
R374, R474	5183050000	47 Ω
R375, R475	5183070000	330 Ω
R376, R476	5183108000	12k Ω
R377	5183082000	1k Ω
R378, R478	5183122000	47k Ω
CAPACITORS		
C370, C470	5173037800	Elec. 47 μ F 25V
C371, C471	5173571800	Elec. 10 μ F 16V
C372, C472	5172318000	Ceramic 220 μ F 50V 10%
C373, C473	5173044800	Elec. 100 μ F 10V
C374, C474	5173556800	Elec. 1 μ F 50V
MISCELLANEOUS		
J9	5122149000	Connector Plug, 6P (WHT)

JOINT PCB ASSY

REF. NO.	PARTS NO.	DESCRIPTION
	5200014120	PCB Assy [U]
	5200014130	PCB Assy [All except U]
	5210014100	PCB [U]
	5210022300	PCB [All except U]
TRANSISTOR		
Q692	5231756800	2SD826EFG
DIODES		
D693~D695	5224013210	DS135D
CARBON RESISTORS		
R693	5183076000	560 Ω 5% $\frac{1}{4}$ W
R694	Δ 5183038000	15 Ω 5% $\frac{1}{4}$ W
CAPACITORS		
C691, C692	5173010800	Elec. 10 μ F 16V
C694	5172324000	Ceramic 0.001 μ F 50V 10%
MISCELLANEOUS		
P691	5122163000	Connector Plug, 10P (WHT)
P692	5122148000	Connector Plug, 5P (WHT)

[U]: U.S.A.
 [A]: AUSTRALIA
 [L]: LIMITED AREA

[C]: CANADA
 [E]: EUROPE

[GE]: GENERAL EXPORT
 [UK]: U.K.

DBX PCB ASSY

REF. NO.	PARTS NO.	DESCRIPTION
	5200035100	PCB Assy
	5210035100	PCB
	IC's	
U701, U801	5220407100	TL082CP
U702, U802	5220406700	PC4558P
U703, U803	5220407100	TL082CP
U704, U804	5220407100	TL082CP
U705, U805	5220406700	PC4558P
U706, U806	5220407100	TL082CP
	TRANSISTORS	
Q701, Q801	5230771400	2SC1815(L) GR
Q702, Q802	5230771400	2SC1815(L) GR
Q703, Q803	5232250300	UPA75VF
Q704, Q804	5232250100	UPA74VF
Q705, Q805	5232250100	UPA74VF
Q706, Q806	5230774300	2SC1845F
Q707, Q807	5222250100	UPA74VF
Q708, Q808	5232250100	UPA74VF
Q709, Q809	5230771400	2SC1815(L) GR
Q710, Q810	5230771400	2SC1815(L) GR
Q711, Q811	5230771400	2SC185(L) GR
Q712, Q812	5230771400	2SC1815(L) GR
Q713, Q813	5232250300	UPA75VF
Q714, Q814	5232250100	UPA74VF
Q715, Q815	5232250100	UPA74VF
Q716, Q816	5230774300	2SC1845F
Q717, Q817	5232250100	UPA74VF
Q718, Q818	5232250100	UPA74VF
Q719, Q819	5230771400	2SC1815(L) GR
Q720, Q820	5230771400	2SC1815(L) GR
	CARBON RESISTORS	
All resistors are rated $\pm 5\%$ tolerance and $\frac{1}{4}$ watt.		
R701, R801	5183123000	51k Ω
R702, R802	5183131000	110k Ω
R703, R803	5183154000	1M Ω
R704, R804	5183100000	5.6k Ω
R705, R805	5183082000	1k Ω
R706, R806	5183130000	100k Ω
R707, R807	5183117000	30k Ω
R708, R808	5183130000	100k Ω
R709, R809	5183048000	39 Ω
R710, R810	5183079000	750 Ω
R711, R811	5183086000	1.5k Ω
R712, R812	5183100000	5.6k Ω
R713, R813	5185066000	82 Ω
R714, R814	5183048000	39 Ω
R715, R815	5185066000	82 Ω
R716, R816	5185066000	82 Ω
R717, R817	5185066000	82 Ω
R718, R818	5183082000	1k Ω
R719, R819	5183130000	100k Ω
R720, R820	5183120000	29k Ω
R721, R821	5183117000	30k Ω
R722, R822	5183074000	100 Ω
R723, R823	5183074000	470 Ω
R724, R824	5183122000	47k Ω
R725, R825	5183122000	47k Ω

REF. NO.	PARTS NO.	DESCRIPTION
R726, R826	5183082000	1k Ω
R727, R827	5183100000	5.6k Ω
R728, R828	5183134000	150k Ω
R729, R829	5183154000	1M Ω
R730, R830	5183146000	470k Ω
R731, R831	5183142000	330k Ω
R732, R832	5183154000	1M Ω
R733, R833	5183026000	4.7 Ω
R734, R834	5183100000	5.6k Ω
R735, R835	5183084000	1.2k Ω
R736, R836	5183082000	1k Ω
R737, R837	5183082000	1k Ω
R738, R838	5183082000	1k Ω
R739, R839	5185116000	10k Ω
R740, R840	5185116000	10k Ω
R741, R841	5183094000	3.3k Ω
R742, R842	5183118000	33k Ω
R743, R843	5183100000	5.6k Ω
R744, R844	5183106000	10k Ω
R745, R845	5183112000	18k Ω
R746, R846	5183101000	6.2k Ω
R747, R847	5183121000	43k Ω
R748, R848	5183129000	91k Ω
R749, R849	5183158000	1.5M Ω
R750, R850	5183123000	51k Ω
R751, R851	5183131000	110k Ω
R752, R852	5183154000	1M Ω
R753, R853	5183100000	5.6k Ω
R754, R854	5183082000	1k Ω
R755, R855	5183130000	100k Ω
R756, R856	5183117000	30k Ω
R757, R857	5183130000	100k Ω
R758, R858	5183048000	39 Ω
R759, R859	5183079000	750 Ω
R760, R860	5183086000	1.5k Ω
R761, R861	5183100000	5.6k Ω
R762, R862	5185066000	82 Ω
R763, R863	5183048000	39 Ω
R764, R864	5185066000	82 Ω
R765, R865	5185066000	82 Ω
R766, R866	5185066000	82 Ω
R767, R867	5183082000	1k Ω
R768, R868	5183120000	39k Ω
R769, R869	5183130000	100k Ω
R770, R870	5183117000	30k Ω
R771, R871	5183086000	100 Ω
R772, R872	5183074000	470 Ω
R773, R873	5183122000	47k Ω
R774, R874	5183122000	47k Ω
R775, R875	5183082000	1k Ω
R776, R876	5183100000	5.6k Ω
R777, R877	5183134000	150k Ω
R778, R878	5183154000	1M Ω
R779, R879	5183146000	470k Ω
R780, R880	5183142000	330k Ω
R781, R881	5183154000	1M Ω
R782, R882	5183026000	4.7 Ω
R783, R883	5183100000	5.6k Ω
R784, R884	5183084000	1.2k Ω
R785, R885	5183082000	1k Ω

IN/OUTPUT TERMINAL PCB ASSY (PC Board Omitted)

REF. NO.	PARTS NO.	DESCRIPTION
R786, R886	5183082000	1k Ω
R787, R887	5183082000	1k Ω
R788, R888	5185116000	10k Ω
R789, R889	5185116000	10k Ω
R790, R890	5183094000	3.3k Ω
R791, R891	5183118000	33k Ω
R792, R892	5183100000	5.6k Ω
R793, R893	5183106000	10k Ω
R794, R894	5183112000	18k Ω
R795, R895	5183101000	6.2k Ω
R796, R896	5183121000	43k Ω
R797, R897	5183129000	91k Ω
R798, R898	5183156000	1.5M Ω
R901, R001	5183122000	47k Ω
R902, R002	5183058000	100 Ω
R903, R003	5183122000	47k Ω
R904, R004	5183058000	100 Ω

CAPACITORS

C701, C801	5260225712	Elec.	0.22 μ F	50V	10%
C702, C802	5163162613	Metalized	0.22 μ F	50V	5%
C703, C803	5263162613	Metalized	0.22 μ F	50V	5%
C704, C804	5172310000	Ceramic	68pF	50V	10%
C705, C805	5172308000	Ceramic	47pF	50V	10%
C706, C806	5173037800	Elec.	47 μ F	25V	
C707, C807	5173561800	Elec.	3.3 μ F	25V	
C708, C808	5170413000	Mylar	0.0033 μ F	100V	5%
C709, C809	5172300000	Ceramic	10pF	50V	10%
C710, C810	5173036900	Elec.	47 μ F	16V	
C711, C811	5260227512	Elec.	22 μ F	10V	10%
C712, C812	5172300000	Ceramic	10pF	50V	10%
C713, C813	5170425000	Mylar	0.01 μ F	100V	5%
C714, C814	5263162213	Metalized	0.1 μ F	50V	5%
C715, C815	5172319000	Ceramic	330pF	50V	10%
C716, C816	5170413000	Mylar	0.0033 μ F	100V	5%
C717, C817	5170413000	Mylar	0.0033 μ F	100V	5%
C718, C818	5263162213	Metalized	0.1 μ F	50V	5%
C719, C819	5263162213	Metalized	0.1 μ F	50V	5%
C720, C820	5260225712	Elec.	0.22 μ F	50V	10%
C721, C821	5263162613	Metalized	0.22 μ F	50V	5%
C722, C822	5263162613	Metalized	0.22 μ F	50V	5%
C723, C823	5170413000	Mylar	0.0033 μ F	100V	5%
C724, C824	5172308000	Ceramic	47pF	50V	10%
C725, C825	5173037800	Elec.	47 μ F	25V	
C726, C826	5173561800	Elec.	3.3 μ F	25V	
C727, C827	5172309000	Ceramic	56pF	50V	10%
C728, C828	5172300000	Ceramic	10pF	50V	10%
C729, C829	5173036900	Elec.	47 μ F	16V	
C730, C830	5260227512	Elec.	22 μ F	10V	10%
C731, C831	5172300000	Ceramic	10pF	50V	10%
C732, C832	5170425000	Mylar	0.01 μ F	100V	5%
C733, C833	5263162213	Metalized	0.1 μ F	50V	5%
C734, C834	5172318000	Ceramic	230pF	50V	10%
C735, C835	5170413000	Mylar	0.0033 μ F	100V	5%
C736, C836	5170413000	Mylar	0.0033 μ F	100V	5%
C737, C837	5263162213	Metalized	0.1 μ F	50V	5%
C738, C838	5263162213	Metalized	0.1 μ F	50V	5%

REF. NO.	PARTS NO.	DESCRIPTION
	5200013400	PCB Assy [U]
	5200013410	PCB Assy [All except U]
	5210013400	PCB [U]
	5210021500	PCB [All except U]
R379, R479 P13	5183120000	Resistor, Carbon 39k Ω 5% 1/4W
	5122129000	Connector Plug, 5P (WHT)

SWITCH PCB ASSY (MEMORY) (PC Board Omitted)

REF. NO.	PARTS NO.	DESCRIPTION
	5200013700	PCB Assy (Memory) [U]
	5200013710	PCB Assy (Memory) [All except U]
	6210013700	PCB (Memory) [U]
	5210021800	PCB (Memory) [All except U]
Q691	5145981000	Transistor, 2SC945AK
R691	5183086000	Resistor, Carbon 1.5k Ω 5% 1/4W
R692	5183076000	Resistor, Carbon 560 Ω 5% 1/4W
S691	5133019000	Switch, Rotary; 2-3

SWITCH PCB ASSY (TIMER) (PC Board Omitted)

REF. NO.	PARTS NO.	DESCRIPTION
	5200013600	PCB Assy (Timer) [U]
	5200013610	PCB Assy (Timer) [All except U]
	5210013600	PCB (Timer) [U]
	5210021700	PCB (Timer) [All except U]
D691, D692	5224013210	Diode DS135D [U]
D691, D692	5224012510	Diode, 1S2076 [All except U]
S692	5133019000	Switch, Rotary; 2-3

[U]: U.S.A.
[A]: AUSTRALIA
[L]: LIMITED AREA

[C]: CANADA
[E]: EUROPE

[GE]: GENERAL EXPORT
[UK]: U.K.

REMOTE CONNECTOR PCB ASSY (PC Board Omitted)

REED SWITCH PCB ASSY (PC Board Omitted)

REF. NO.	PARTS NO.	DESCRIPTION
	5200013500	PCB Assy [U]
	5200013510	PCB Assy [All except U]
	5210013500	PCB [U]
	5210021600	PCB [All except U]
	5122336000	Connector Socket, 12P

REF. NO.	PARTS NO.	DESCRIPTION
	5200018400	PCB Assy [U]
	5200018410	PCB Assy [All except U]
	5210018400	PCB [U]
	5210022500	PCB [All except U]
	5138006000	Switch, Reed
	5054802000	Capacitor, Mylar 0.01 μ F 100V 10%

(Continued from page 25)

Parts marked with *require longer delivery time.















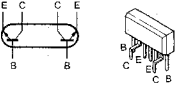









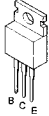

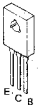

REF. NO.	PARTS NO.	DESCRIPTION	REMARKS
4 - 52	*5524124000	Spring, GND	
4 - 53	*5800069201	Bracket, Switch	C-3X
4 - 54	*5800064900	Chassis, Front	C-3X
4 - 55	5124022000	Jack, PHONES	
4 - 56	*5200013700	PCB Assy, SW (MEMORY) [U]	C-3X
	*5200013710	PCB Assy, SW (MEMORY) [All except U]	
4 - 57	*5200013600	PCB Assy, SW (TIMER) [U]	C-3X
	*5200013610	PCB Assy, W (TIMER) [All except U]	
4 - 58	5133019000	Switch, Rotary; 2-3	A-300
4 - 59	5534431000	Button, B	
4 - 60	*5534422100	Rod, Power Switch	A-300
4 - 61	*5786360500	R Pin, $\phi 5$	
4 - 62	*5555561000	Bracket, Power Switch	A-500
4 - 63	Δ 5052906000	Spark Killer, 0.033 μ F + 120 Ω /250V [U]	
	Δ 5052907000	Spark Killer, 0.01 μ F + 300 Ω /300V [GE, L]	
	Δ 5052911000	Spark Killer, 0.033 μ F + 120 Ω /250V [C]	
	Δ 5267702500	Spark Killer, 0.047 μ F/250V [E, UK, A]	
4 - 64	Δ 5134018000	Switch, Power [U, C]	
	Δ 5134011000	Switch, Power [E, UK, A]	
	Δ 5134009000	Switch, Power [GE, L]	
4 - 65	*5504676000	Foot	A-500
4 - 66	*5551031200	Chassis, R [All except L]	A-500
		Chassis Assy, R [L]	A-500
4 - 67	*5555951001	Heat Sink	A-650
4 - 68	*5200014120	PCB Assy, POWER SUPPLY [U]	C-3X
	*5200014130	PCB Assy, POWER SUPPLY [All except U]	
4 - 69	*5033291000	Plate, Insulating	
4 - 70	*6231755100	Transistor, 2SD80Y	
4 - 71	*5317003000	Plate, Insulating; A	C-3X
4 - 72	*5231755500	Transistor, 2SD885	
4 - 73	*5033295000	Tube, Insulating	
4 - 74	*5553353100	Bracket, Transformer	C-3
4 - 75	*5555062000	Bracket, A [GE, L]	
4 - 76	*5168548100	PCB Assy, VOLTAGE SELECTOR [GE, L]	
4 - 77	Δ 5320007300	Transformer, Power [U, C]	
	Δ 5320007400	Transformer, Power [GE, L]	
	Δ 5320007500	Transformer, Power [E, UK, A]	
4 - 78	*5555626000	Washer, Transformer	A-500
4 - 79	*5200036600	PCB Assy, FUSE [E, UK, A]	

[U]: U.S.A.
[A]: AUSTRALIA
[L]: LIMITED AREA

[C]: CANADA
[E]: EUROPE

[GE]: GENERAL EXPORT
[UK]: U.K.

TABLE OF SEMICONDUCTORS

<p>JRC4558DF RC4558P TL082CP (TOP VIEW)</p> 	<p>LA4170 (TOP VIEW)</p> 	<p>M54410P (TOP VIEW)</p> 	<p>NE645B (TOP VIEW)</p> 	<p>μPA75V(F)</p> 	
<p>2SA733P 2SA933LNS 2SC1815GR 2SC1845(F)</p>  	<p>2SC1327T 2SC1684S 2SC1841A 2SC1844F 2SC345AK 2SD655E</p>  	<p>2SA934R</p>  	<p>2SC2060R</p>  	<p>2SB750(R)</p>  	<p>2SD880Y</p>  
<p>2SC1636-2 2SC1637-1</p>  	<p>2SC2270A-B 2SD985</p>  	<p>2SK68AM1</p>  	<p>1S2076</p>  <p>EQA01-06R EQA01-13RF</p> 		<p>DS135D</p>  <p>RD4.3EB RD13EB</p>  <p>SLP-114B TLG123A</p> 

C-3RX

TEAC[®]

TEAC CORPORATION

3-7-3 NAKA-CHO MUSASHINO TOKYO PHONE (0422) 53-1111

TEAC CORPORATION OF AMERICA

7733 TELEGRAPH ROAD MONTEBELLO CALIFORNIA 90640 PHONE (213) 726-0303

TEAC AUSTRALIA PTY., LTD

115 WHITEMAN STREET SOUTH MELBOURNE VICTORIA 3205 PHONE 699-8000

PRINTED IN JAPAN 0681 AT 1.7 D-3729A

1

2

3

4

A

B

C

D

E

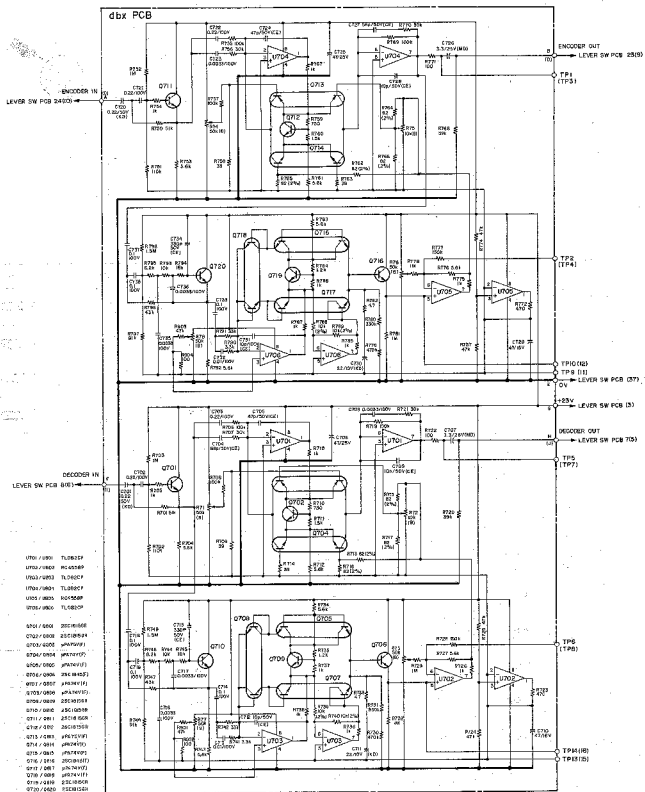

ASSEMBLING HARDWARE CODING LIST

All screws conform to ISO standards, and have crossrecessed heads, unless otherwise noted. ISO screws have the head inscribed with a point as in the figure to the right.

FOR EXAMPLE:

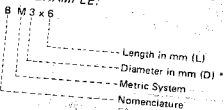

* Inner dia. for washers and nuts

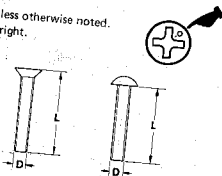

	Code	Name	Type		Code	Name	Type	
MACHINE SCREW	R	Round Head Screw		TAPPING SCREW	BTA	Binding Head Tapping Screw(A Type)		
	P	Pan Head Screw			BTB	Binding Head Tapping Screw(B Type)		
	T	Stove Head Screw (Truss)			RTA	Round Head Tapping Screw(A Type)		
	B	Binding Head Screw			RTB	Round Head Tapping Screw(B Type)		
	F	Flat Countersunk Head Screw			SETScrew	SF	Hex Socket Setscrew(Flat Point)	
	O	Oval Countersunk Head Screw				SC	Hex Socket Setscrew(Cup Point)	
RW	Round Head Wood Screw		SS	Slotted Socket Setscrew(Flat Point)				
WOOD SCREW	RW	Round Head Wood Screw		WASHER	E	E-Ring (Retaining Washer)		
TAPTITE SCREW	PTT	Pan Head TapTite Screw			W	Flat Washer (Plain)		
	WTT	Washer Head TapTite Screw			SW	Lock Washer (Spring)		
SEMS SCREW	BSA	Binding Head SEMS Screw(A Type)			LWI	Lock Washer (Internal Teeth)		
	BSB	Binding Head SEMS Screw(B Type)			LWE	Lock Washer (External Teeth)		
	BSF	Binding Head SEMS Screw(F Type)			TW	Trim Washer (Countersunk)		
	PSA	Pan Head SEMS Screw(A Type)			NUT	N	Hex Nut	
	PSB	Pan Head SEMS Screw(B Type)						

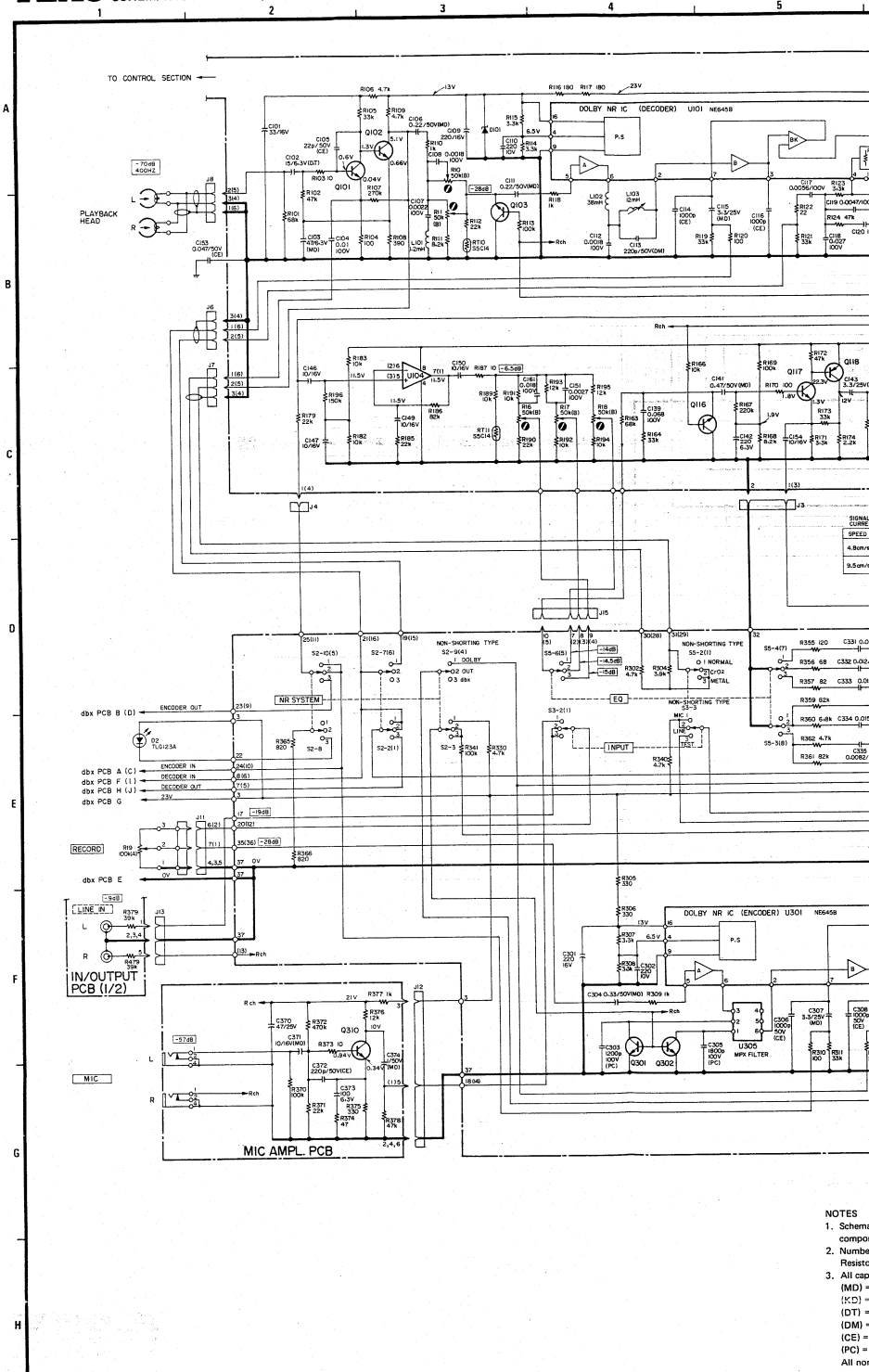

- NOTES
1. Schematic component
 2. Number Resistor
 3. All codes (MD) = (KD) = (DT) = (DM) = (CE) = (PC) = F All non

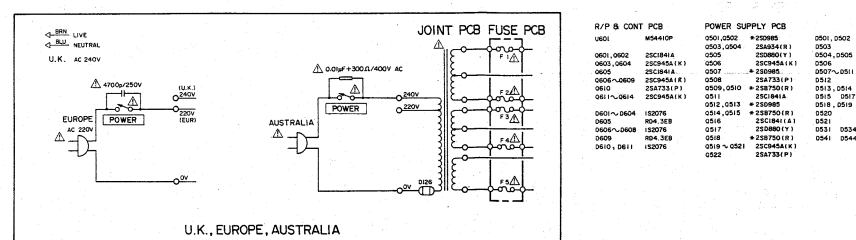
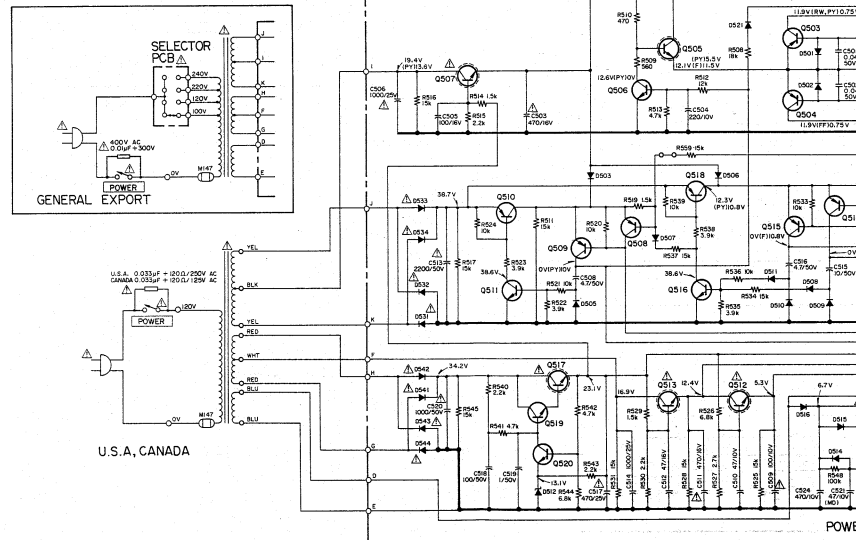
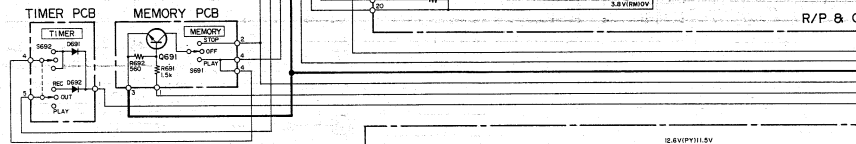
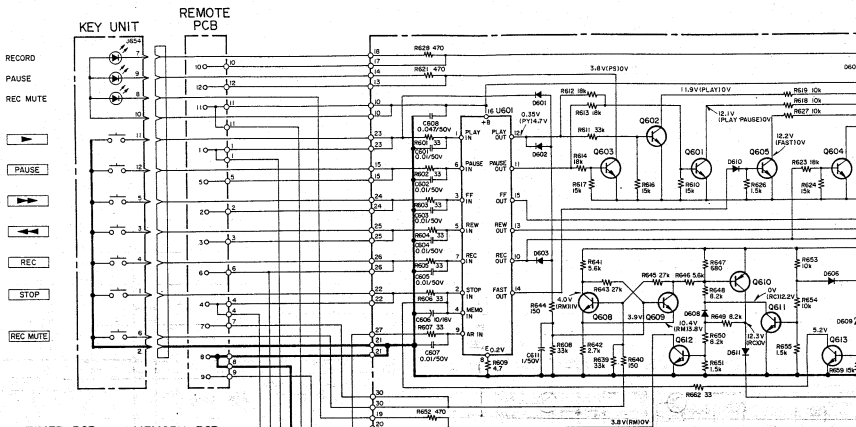

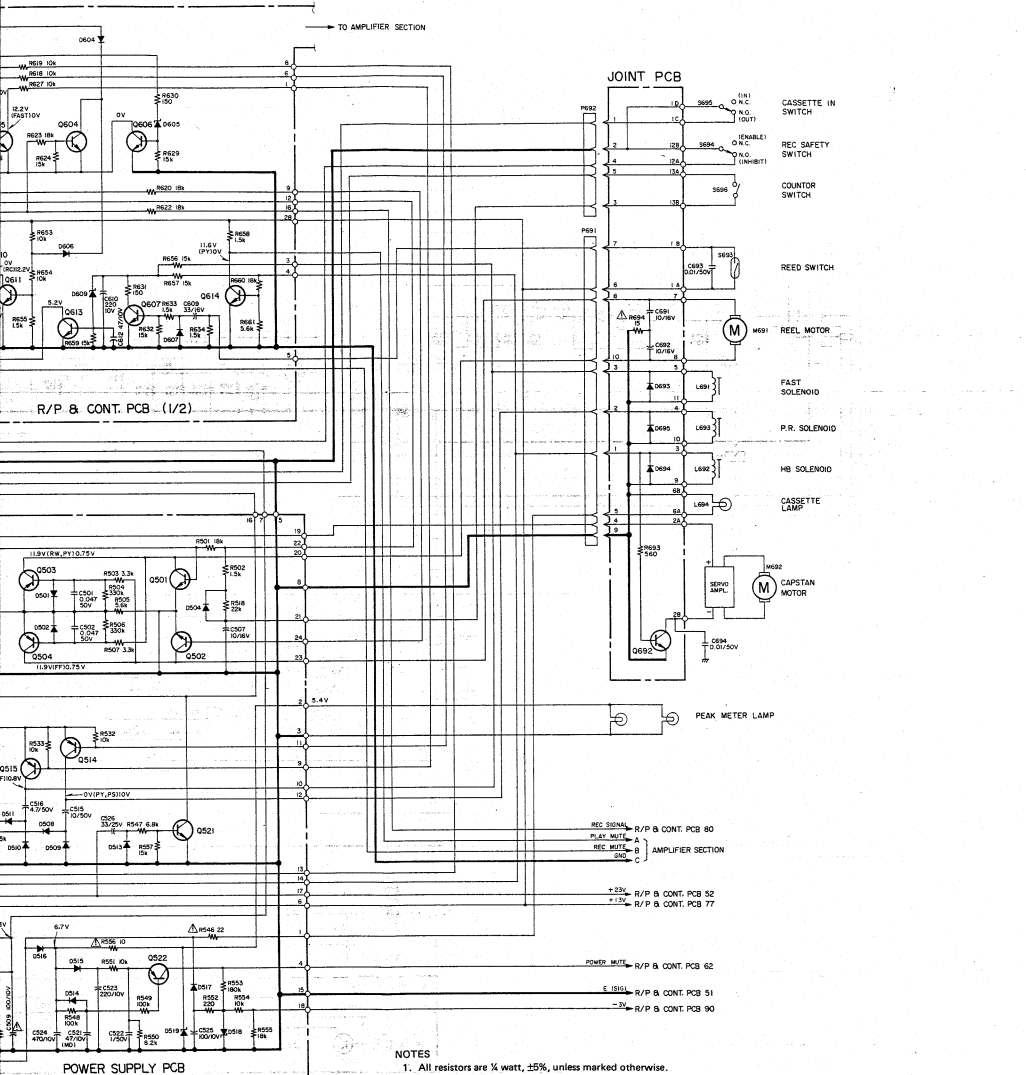

- NOTES**
- All resistors are 1/4 watt, 5%, unless marked otherwise. Resistor values are in ohms (k = 1,000 ohms).
 - All capacitor values are in microfarads (µ = picofarads). (MD) = Electrolytic capacitor MD series
 - All non-polarized capacitors are ±5% mylar unless otherwise specified.
 - Parts marked with this sign are safety critical components. They must always be replaced with identical components - refer to the TEAC parts list and ensure exact replacement.
 - Each Voltage value shown above is the one measured in STOP position and each mode.
- ST : STOP PY : PLAY PS : PAUSE
 FF : FIRST FORWARD RW : REWIND
 RC : REC PLAY RM : REC MUTING
- : front panel indication
 - ▨ : rear panel indication
 - +B : power supply circuit

RESISTOR VALUES

0501, 0502	132076
0503	013330
0504, 0505	152076
0506	013330
0507 ~ 0511	152076
0512	RD 33B
0513, 0514	152076
0515, 0517	013330
0518, 0519	013330
0520	1W1 10001
0521	152076
0531	013330
0541	013330

MEMORY PCB

0691, 0692	093350
0691	25C045A1K1

CONNECTOR PCB

0687	31C2270 w 230485
0692 ~ 0694	013330

TIMER PCB

1P DARLINGTON PAIR TRANSISTOR